



FILTRATION



SEPARATION



PURIFICATION



www.hydroscientific.net
sales@hydronixwater.com

A **HYDRONIX™** Company
HydroScientific™ is a registered trademark
and a division of Hydronix Water Technology™







COMPANY PROFILE

FILTRATION • SEPARATION • PURIFICATION

HydroScientific™ offers innovative solutions to help customers worldwide satisfy their needs in the Filtration, Separation and Purification market. Our goal is to address the needs of a demanding market segment that requires a product that delivers a solution to a variety of applications but is also cost effective.

FILTRATION

HydroScientific™ has developed a broad range of products that help customers improve process fluid purity, protect their process, increase productivity and greatly reduce their manufacturing costs. As a global premier supplier, HydroScientific's goal is to provide every customer with efficiency and an impressive cost to benefit ratio.

SEPARATION

We understand the challenges our customers face. Whether its beer or wine, bottled water, soft drinks, juice or dairy, HydroScientific has a comprehensive line of products which can be used in critical steps in your production applications. We understand the importance of water processing, clarification and particulate control while increasing reliability.

PURIFICATION

With a growing global demand for special and innovative resins, paints and coatings, HydroScientific™ recognizes the importance of delivering a quality product that can be used for a broad range of applications. From specialty coatings and resins to automotive top coats and inks HydroScientific™ strives to address your product needs and exceed your expectations.



© 2020-2021 HYDROSCIENTIFIC | All Rights Reserved.



PLEATED JUMBO HIGH FLOW FILTER CARTRIDGES

HSC SERIES



HYDROSCIENTIFIC™ PLEATED JUMBO CARTRIDGES

are high flow performance cartridges designed to meet and exceed operational requirements in high flow applications. Their 100% Polyester material is ideal for almost every application where a rugged, cleanable and reusable cartridge is required.

HYDROSCIENTIFIC™ PLEATED JUMBO CARTRIDGES

deliver high flow capability while reducing filter change-outs due to their high dirt holding capacity and increased particle removal. HSC Series Cartridges are surfactant and binder free, incorporate a built-in seal and are available in a wide range of sizes and micron ratings.

HSC SERIES - PLEATED JUMBO CARTRIDGE SPECIFICATIONS									
Cartridge Length	Part Number	Description	Micron Rating (µ)	Rcmd. Flow Rate (gpm)**	Max. Flow Rate (gpm)**	Max. Flow Rate (lpm)**	Max. Flow Rate (m ³ /hr)**	Box Dimension (Inches)	Case Qty (pcs)
9 5/8"	HSC-40-0.2-PPA	HydroScientific™ Pleated All Poly Jumbo, 7 3/4" x 9 5/8", Absolute	0.2	35	50	189	12	9" x 9" x 11"	1
	HSC-40-0.35-PPA	HydroScientific™ Pleated All Poly Jumbo, 7 3/4" x 9 5/8", Absolute	0.35	35	50	189	12	9" x 9" x 11"	1
	HSC-40-0.45-PPA	HydroScientific™ Pleated All Poly Jumbo, 7 3/4" x 9 5/8", Absolute	0.45	35	50	189	12	9" x 9" x 11"	1
	HSC-40-1-PPA	HydroScientific™ Pleated All Poly Jumbo, 7 3/4" x 9 5/8", Absolute	1	35	50	189	12	9" x 9" x 11"	1
	HSC-40-1	HydroScientific™ Pleated Synthetic Jumbo, 7 3/4" x 9 5/8"	1	35	50	189	12	9" x 9" x 11"	1
	HSC-40-5	HydroScientific™ Pleated Synthetic Jumbo, 7 3/4" x 9 5/8"	5	35	50	189	12	9" x 9" x 11"	1
	HSC-40-10	HydroScientific™ Pleated Synthetic Jumbo, 7 3/4" x 9 5/8"	10	35	50	189	12	9" x 9" x 11"	1
	HSC-40-20	HydroScientific™ Pleated Synthetic Jumbo, 7 3/4" x 9 5/8"	20	35	50	189	12	9" x 9" x 11"	1
	HSC-40-50	HydroScientific™ Pleated Synthetic Jumbo, 7 3/4" x 9 5/8"	50	35	50	189	12	9" x 9" x 11"	1
19 1/2"	HSC-90-0.2-PPA	HydroScientific™ Pleated All Poly Jumbo, 7 3/4" x 19 1/2", Absolute	0.2	70	100	378	24	9" x 9" x 21"	1
	HSC-90-0.35-PPA	HydroScientific™ Pleated All Poly Jumbo, 7 3/4" x 19 1/2", Absolute	0.35	70	100	378	24	9" x 9" x 21"	1
	HSC-90-0.45-PPA	HydroScientific™ Pleated All Poly Jumbo, 7 3/4" x 19 1/2", Absolute	0.45	70	100	378	24	9" x 9" x 21"	1
	HSC-90-1-PPA	HydroScientific™ Pleated All Poly Jumbo, 7 3/4" x 19 1/2", Absolute	1	70	100	378	24	9" x 9" x 21"	1
	HSC-90-1	HydroScientific™ Pleated Synthetic Jumbo, 7 3/4" x 19 1/2"	1	70	100	378	24	9" x 9" x 21"	1
	HSC-90-5	HydroScientific™ Pleated Synthetic Jumbo, 7 3/4" x 19 1/2"	5	70	100	378	24	9" x 9" x 21"	1
	HSC-90-10	HydroScientific™ Pleated Synthetic Jumbo, 7 3/4" x 19 1/2"	10	70	100	378	24	9" x 9" x 21"	1
	HSC-90-20	HydroScientific™ Pleated Synthetic Jumbo, 7 3/4" x 19 1/2"	20	70	100	378	24	9" x 9" x 21"	1
	HSC-90-50	HydroScientific™ Pleated Synthetic Jumbo, 7 3/4" x 19 1/2"	50	70	100	378	24	9" x 9" x 21"	1
30 3/4"	HSC-170-0.2-PPA	HydroScientific™ Pleated All Poly Jumbo, 7 3/4" x 30 3/4", Absolute	0.2	105	150	568	36	9" x 9" x 32"	1
	HSC-170-0.35PPA	HydroScientific™ Pleated All Poly Jumbo, 7 3/4" x 30 3/4", Absolute	0.35	105	150	568	36	9" x 9" x 32"	1
	HSC-170-0.45PPA	HydroScientific™ Pleated All Poly Jumbo, 7 3/4" x 30 3/4", Absolute	0.45	105	150	568	36	9" x 9" x 32"	1
	HSC-170-1-PPA	HydroScientific™ Pleated All Poly Jumbo, 7 3/4" x 30 3/4", Absolute	1	105	150	568	36	9" x 9" x 32"	1
	HSC-170-1	HydroScientific™ Pleated Synthetic Jumbo, 7 3/4" x 30 3/4"	1	105	150	568	36	9" x 9" x 32"	1
	HSC-170-5	HydroScientific™ Pleated Synthetic Jumbo, 7 3/4" x 30 3/4"	5	105	150	568	36	9" x 9" x 32"	1
	HSC-170-10	HydroScientific™ Pleated Synthetic Jumbo, 7 3/4" x 30 3/4"	10	105	150	568	36	9" x 9" x 32"	1
	HSC-170-20	HydroScientific™ Pleated Synthetic Jumbo, 7 3/4" x 30 3/4"	20	105	150	568	36	9" x 9" x 32"	1
	HSC-170-50	HydroScientific™ Pleated Synthetic Jumbo, 7 3/4" x 30 3/4"	50	105	150	568	36	9" x 9" x 32"	1
	HSC-170-100	HydroScientific™ Pleated Synthetic Jumbo, 7 3/4" x 30 3/4"	100	105	150	568	36	9" x 9" x 32"	1
HSC-170-150	HydroScientific™ Pleated Synthetic Jumbo, 7 3/4" x 30 3/4"	150	105	150	568	36	9" x 9" x 32"	1	

PLEATED JUMBO HIGH FLOW FILTER CARTRIDGES

HSC SERIES



APPLICATIONS

- Desalination Prefiltration
- Residential, Commercial, Industrial
- Cooling Tower Filtration
- Whole House Filtration
- Process Water
- Well Water
- Industrial Waste Water Treatment
- Reverse Osmosis Prefiltration

FEATURES

- Available in three sizes 9 5/8", 19 1/2" and 30 3/4".*
- Cleanable and reusable in most micron ratings and filtration applications.
- 0.2, 0.35, 0.45, 1, 5, 10, 20, 50, 100 and 150 Micron Ratings.
- Complies with NSF/ANSI Standard 61 Material Safety Requirements.
- 100% Surfactant and Binder Free.
- High Flow Rates, Lower Initial Pressure Drop.
- Longer Life, Longer Filter Runs.
- FDA / USP Material Safety Compliant.

OPERATIONAL DATA

Max. Operating Temperature: 140° F (60° C)**

MATERIALS OF CONSTRUCTION

Filter Media: Pleated Polyester
 End Caps: Plastisol
 Center Tubes: ABS or PVC

Filter Media (Absolute): Polypropylene
 End Caps (Absolute): Polypropylene
 Center Tubes (Absolute): Polypropylene

* Custom sizes available upon request.

** HydroScientific recommends operation at 70% of maximum flow rate for optimum performance.

*** Temperature limits vary and depend on pressure and time under load.

FDA / USP Material Safety Compliance - All materials comply with FDA requirements for food and beverage contact per CFR Title 21 174.5, 177.1520 and 177.1630. All components meet USP Class VI Plastics.

Copyright © 2019 HydroScientific., All Rights Reserved.

HSC SERIES DIMENSIONS

MODEL	A Length	B Diameter
HSC-40	9 5/8"	7 3/4"
HSC-90	19 1/2"	7 3/4"
HSC-170	30 3/4"	7 3/4"

HSC SERIES SPECIFICATIONS

MODEL	Media (sq ft)
HSC-40	40
HSC-90	90
HSC-170	170

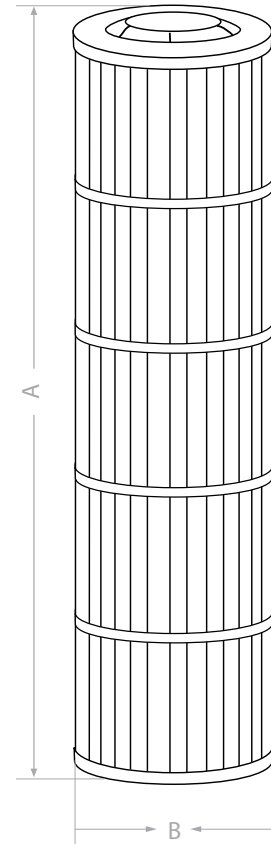

INITIAL PRESSURE DROP

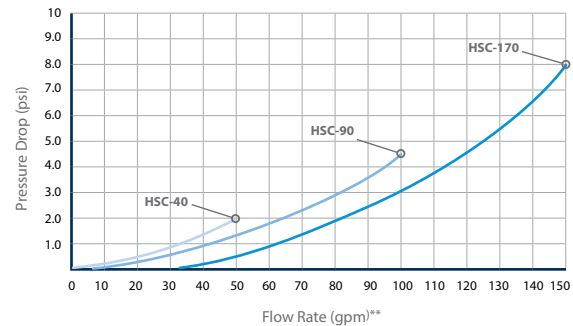

Pressure drop shown above is for filter housing and 20 micron filter cartridge in clean water.



HIGH FLOW FILTER CARTRIDGES

HHFEC SERIES



HYDROSCIENTIFIC™ HHFEC HIGH FLOW CARTRIDGES

are highly efficient and easy to use cartridges designed for residential, commercial and light industrial filtration applications. Their rigid outer cage replaces costly bag filter baskets and provide an easy to use push/pull application.

HYDROSCIENTIFIC™ HHFEC HIGH FLOW CARTRIDGES

deliver high flow capability while reducing filter change-outs due to their high dirt holding capacity and increased particle removal. HHFEC Series Cartridges are designed for high flow and long service life. Available in a wide range of sizes and micron ratings.

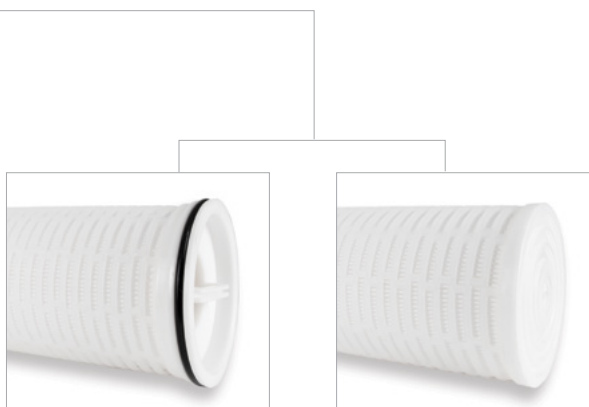

HHFEC SERIES - HIGH FLOW CARTRIDGE SPECIFICATIONS

Part Number	Description	Material	Nominal Micron Rating (μ)	Max. Flow Rate (gpm)	Max. Flow Rate (lpm)	Max. Flow Rate (m ³ /hr)	Box Dimension (Inches)	Box Qty (pcs)
HHFEC-0.5	HydroScientific™ High Flow, 23"	PP	0.5	60	227.2	13.63	7" x 7" x 24"	1
HHFEC-1	HydroScientific™ High Flow, 23"	PP	1	80	302.8	18.17	7" x 7" x 24"	1
HHFEC-5	HydroScientific™ High Flow, 23"	PP	5	120	454.2	27.25	7" x 7" x 24"	1
HHFEC-10	HydroScientific™ High Flow, 23"	PP	10	150	567.8	34.07	7" x 7" x 24"	1
HHFEC-20	HydroScientific™ High Flow, 23"	PP	20	150	567.8	34.07	7" x 7" x 24"	1
HHFEC-50	HydroScientific™ High Flow, 23"	PP	50	150	567.8	34.07	7" x 7" x 24"	1
HHFEC-70	HydroScientific™ High Flow, 23"	PP	70	150	567.8	34.07	7" x 7" x 24"	1

PP = POLYPROPYLENE

HIGH FLOW FILTER CARTRIDGES

HHFEC SERIES



APPLICATIONS

- RO Systems
- Water
- Coolants
- Food & Beverage
- Wastewater
- Sea Water
- Desalination
- Chemicals
- Electronics
- Power

FEATURES

- High Flow Rates.
- All polypropylene construction.
- 0.5, 1, 5, 10, 20, 50 and 70 Nominal Micron Ratings.
- 98% retention ratings from .5 to 70 microns.
- Handle provides fast and easy push / pull installation.
- O-ring seal on cartridge eliminates bypass.
- Inside out flow retains contaminant during change out.
- Pleated media designed for high flow and long service life.
- Thermally bonded filter structure.
- NSF Standard 61 Approved Material.
- FDA / USP Material Safety Compliance - All materials comply with FDA requirements for food and beverage contact per CFR Title 21 174.5, 177.1520 and 177.1630. All components meet USP Class VI Plastics.

MATERIALS OF CONSTRUCTION

Filter Media:	Polypropylene
End Caps:	Polypropylene
Body:	Polypropylene
Gaskets:	EPDM standard*

OPERATIONAL DATA

Max. Operating Temperature:	140°F @ 20 psi** (60°C @ 1.4 bar)
-----------------------------	--------------------------------------

RECOMMENDED CHANGEOUT

Differential Pressure:	15 psid (1.0 bar)
------------------------	-------------------

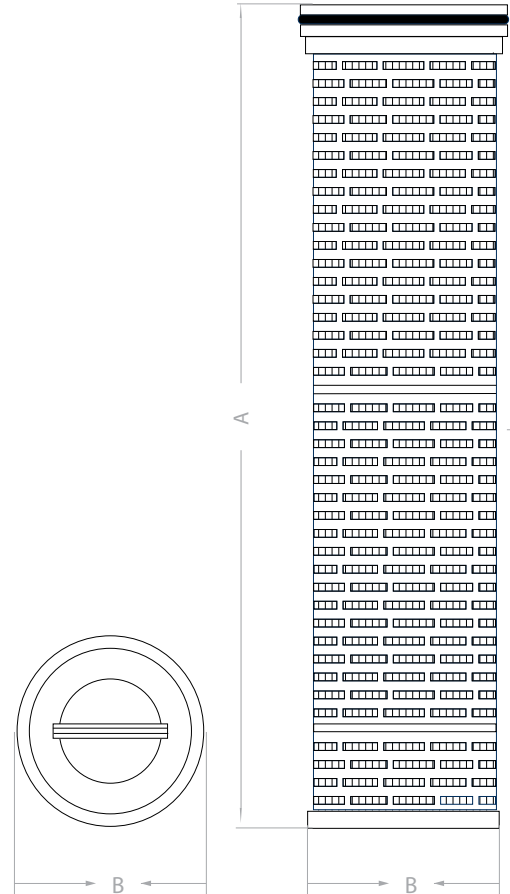

HHFEC SERIES DIMENSIONS

MODEL	A Length	B OD Diameter
HHFEC-23	23"	6"

* Buna-N, Viton, Silicone available upon request.

** Temperature limits vary and depend on pressure and time under load.



BIG FLOW™ FILTER CARTRIDGES

HBBC SERIES



HYDROSCIENTIFIC™ HBBC SERIES BIG FLOW™ CARTRIDGES

are a high-quality alternative to Big Bubba® filter cartridges. Big Flow™ filter cartridges can provide flow rates of up to 150 gpm and are designed to handle a working pressure of up to 125 psi.

HYDROSCIENTIFIC™ HBBC SERIES BIG FLOW™ CARTRIDGES

deliver high flow capability while reducing filter change-outs. Their 100% binder free FDA CFR 21 compliant material is ideal for use in applications where a durable, cleanable**, reliable and reusable** cartridge is required.

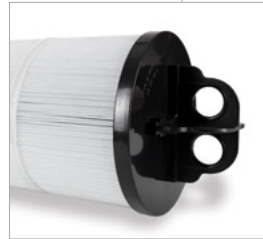

HBBC SERIES - PLEATED BIG FLOW™ FILTER CARTRIDGE SPECIFICATIONS

Part Number	Description	Material	Nominal Micron Rating (μ)	Max. Flow Rate (gpm)	Max. Flow Rate (lpm)	Max. Flow Rate (m³/hr)	Box Dimension (Inches)	Case Qty (pcs)
HBBC-150-P1	HydroScientific™ Pleated Big Flow Filter Cartridge	PP	1	150	567.8	36	7" x 7" x 31"	1
HBBC-150-P5	HydroScientific™ Pleated Big Flow Filter Cartridge	PP	5	150	567.8	36	7" x 7" x 31"	1
HBBC-150-P20	HydroScientific™ Pleated Big Flow Filter Cartridge	PP	20	150	567.8	36	7" x 7" x 31"	1
HBBC-150-P50	HydroScientific™ Pleated Big Flow Filter Cartridge	PP	50	150	567.8	36	7" x 7" x 31"	1
HBBC-150-P150	HydroScientific™ Pleated Big Flow Filter Cartridge	PP	150	150	567.8	36	7" x 7" x 31"	1

HBBC SERIES - DEPTH BIG FLOW™ FILTER CARTRIDGE SPECIFICATIONS

Part Number	Description	Material	Nominal Micron Rating (μ)	Max. Flow Rate (gpm)	Max. Flow Rate (lpm)	Max. Flow Rate (m³/hr)	Box Dimension (Inches)	Case Qty (pcs)
HBBC-150-D1	HydroScientific™ Depth Big Flow Filter Cartridge	PP	1	100	378.5	22.71	7" x 7" x 31"	1
HBBC-150-D5	HydroScientific™ Depth Big Flow Filter Cartridge	PP	5	100	378.5	22.71	7" x 7" x 31"	1
HBBC-150-D20	HydroScientific™ Depth Big Flow Filter Cartridge	PP	20	100	378.5	22.71	7" x 7" x 31"	1
HBBC-150-D50	HydroScientific™ Depth Big Flow Filter Cartridge	PP	50	100	378.5	22.71	7" x 7" x 31"	1

HydroScientific recommends operation at 70% of maximum flow rate for optimum performance. Custom sizes available upon request.

PP = POLYPROPYLENE

** Pleated Cartridges only.

BIG FLOW™ FILTER CARTRIDGES

HBBC SERIES



APPLICATIONS

- Whole House Filtration
- Pre-Filtration for Reverse Osmosis
- Commercial Filtration
- Industrial Filtration
- Farms
- Car Washes
- Hotels
- Food Service
- Agricultural

FEATURES

- Cleanable and Reusable. **
- 1, 5, 20, 50 and 150 Nominal Micron Ratings.
- Surfactant and Binder Free.
- High Flow Rates.
- NSF Standard 61 Approved Material.
- Lower Initial Pressure Drop.
- Higher Loading Capacity.
- Longer Life, Longer Filter Runs.
- FDA / USP Material Safety Compliance - All materials comply with FDA requirements for food and beverage contact per CFR Title 21 174.5, 177.1520 and 177.1630. All components meet USP Class VI Plastics.

MATERIALS OF CONSTRUCTION

Filter Media:	Pleated - Polypropylene Depth - Polypropylene
End Caps:	PP
Center Tubes:	ABS or PVC
O-Ring:	EPDM

OPERATIONAL DATA

Max. Operating Temperature:	125°F (52°C)*
Max. Flow Rate:	Pleated - 150 gpm Depth - 100 gpm
Max. Working Pressure:	125 psi (8.75 bar)

RECOMMENDED CHANGEOUT

Differential Pressure:	30 psid (2.07 bar)
------------------------	--------------------

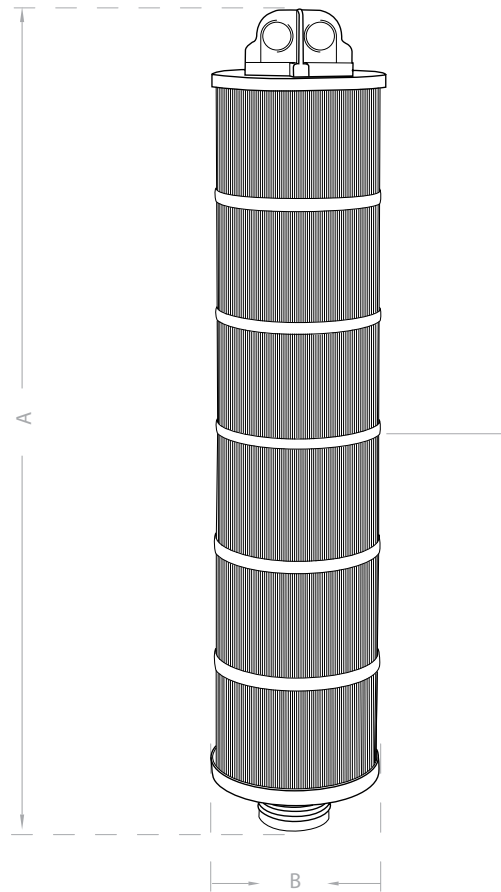

HBBC SERIES DIMENSIONS

MODEL	A Length	B OD Diameter
HBBC	23"	6"

*Temperature limits vary and depend on pressure and time under load.

**Pleated Cartridges only.

DO NOT use with water that is microbiologically unsafe or of unknown quality without adequate disinfection before or after the system.

The name Big Bubba is a registered trademark of Watts Water Quality and Conditioning Products LLC. Watts Water Quality and Conditioning Products LLC is not affiliated with HydroScientific and do not endorse this product.

Copyright © 2019 HydroScientific, All Rights Reserved.



POLYPROPYLENE FILTER BAG

BAG1 / BAG2 SERIES



HYDROSCIENTIFIC™ BAG1 / BAG2 SERIES FILTER BAGS

are durable, reusable polypropylene felt filter bags designed to fit most manufacturers housings. Precise pore sizes and micron ratings from 1 to 200 microns provide high particle retention and a superb solids-loading capacity.

HYDROSCIENTIFIC™ BAG1 / BAG2 SERIES FILTER BAGS

are ideal for applications requiring high efficiency and can be used in a wide range of applications. Glazed for minimal fiber migration and thermally-welded for strength, HydroScientific™ delivers on cost and quality.

BAG1 SERIES - LIQUID BAG FILTER SINGLE LAYER #1 SPECIFICATIONS

Part Number	Description	Nominal Micron Rating (μ)	Case Qty (pcs)	Case Dimension (Inches)	Shipping Weight (lbs)	Shipping Weight (kgs)
BAG1-1M	HydroScientific™ Liquid Bag Filter, Polypropylene Felt, #1, Polypropylene ring	1	50	31" x 17" x 19.3"	24.0	10.9
BAG1-3M	HydroScientific™ Liquid Bag Filter, Polypropylene Felt, #1, Polypropylene ring	3	50	19" x 19" x 19.3"	20.0	9.0
BAG1-5M	HydroScientific™ Liquid Bag Filter, Polypropylene Felt, #1, Polypropylene ring	5	50	19" x 19" x 19.3"	20.0	9.0
BAG1-10M	HydroScientific™ Liquid Bag Filter, Polypropylene Felt, #1, Polypropylene ring	10	50	19" x 19" x 19.3"	20.0	9.0
BAG1-25M	HydroScientific™ Liquid Bag Filter, Polypropylene Felt, #1, Polypropylene ring	25	50	19" x 19" x 19.3"	20.0	9.0
BAG1-50M	HydroScientific™ Liquid Bag Filter, Polypropylene Felt, #1, Polypropylene ring	50	50	19" x 19" x 19.3"	20.5	9.2
BAG1-75M	HydroScientific™ Liquid Bag Filter, Polypropylene Felt, #1, Polypropylene ring	75	50	19" x 19" x 19.3"	20.5	9.2
BAG1-100M	HydroScientific™ Liquid Bag Filter, Polypropylene Felt, #1, Polypropylene ring	100	50	19" x 19" x 19.3"	20.5	9.2
BAG1-150M	HydroScientific™ Liquid Bag Filter, Polypropylene Felt, #1, Polypropylene ring	150	50	19" x 19" x 19.3"	20.5	9.2
BAG1-200M	HydroScientific™ Liquid Bag Filter, Polypropylene Felt, #1, Polypropylene ring	200	50	19" x 19" x 19.3"	20.5	9.2

BAG2 SERIES - LIQUID BAG FILTER SINGLE LAYER #2 SPECIFICATIONS

Part Number	Description	Nominal Micron Rating (μ)	Case Qty (pcs)	Case Dimension (Inches)	Shipping Weight (lbs)	Shipping Weight (kgs)
BAG2-1M	HydroScientific™ Liquid Bag Filter, Polypropylene Felt, #2, Polypropylene ring	1	40	31" x 17" x 19.3"	30.5	13.8
BAG2-3M	HydroScientific™ Liquid Bag Filter, Polypropylene Felt, #2, Polypropylene ring	3	50	31" x 17" x 19.3"	29.7	13.4
BAG2-5M	HydroScientific™ Liquid Bag Filter, Polypropylene Felt, #2, Polypropylene ring	5	50	31" x 17" x 19.3"	29.7	13.4
BAG2-10M	HydroScientific™ Liquid Bag Filter, Polypropylene Felt, #2, Polypropylene ring	10	50	31" x 17" x 19.3"	29.7	13.4
BAG2-25M	HydroScientific™ Liquid Bag Filter, Polypropylene Felt, #2, Polypropylene ring	25	50	31" x 17" x 19.3"	29.7	13.4
BAG2-50M	HydroScientific™ Liquid Bag Filter, Polypropylene Felt, #2, Polypropylene ring	50	50	31" x 17" x 19.3"	29.7	13.4
BAG2-75M	HydroScientific™ Liquid Bag Filter, Polypropylene Felt, #2, Polypropylene ring	75	50	31" x 17" x 19.3"	29.7	13.4
BAG2-100M	HydroScientific™ Liquid Bag Filter, Polypropylene Felt, #2, Polypropylene ring	100	50	31" x 17" x 19.3"	29.7	13.4
BAG2-150M	HydroScientific™ Liquid Bag Filter, Polypropylene Felt, #2, Polypropylene ring	150	50	31" x 17" x 19.3"	29.7	13.4
BAG2-200M	HydroScientific™ Liquid Bag Filter, Polypropylene Felt, #2, Polypropylene ring	200	50	31" x 17" x 19.3"	29.7	13.4

POLYPROPYLENE FILTER BAG

BAG1 / BAG2 SERIES



FEATURES

- Micron Ratings from 1 to 200 microns.
- Durable Polypropylene Felt Standard #1 and #2 Bags.
- Designed to fit most manufacturers housings.
- Polypropylene ring with handle for easy removal.
- High Particle Retention.
- Superb Solids-Loading capacity.
- FDA / USP Material Safety Compliance - All materials comply with FDA requirements for food and beverage contact per CFR Title 21 174.5, 177.1520 and 177.1630. All components meet USP Class VI Plastics.

APPLICATIONS

- Process Water
- Water and Wastewater
- Prefiltration
- Beverages
- Lubricants
- Paints / Inks
- Chemicals
- Coatings

OPERATIONAL DATA

Max. Operating Temperature:	195°F @ 20 psi (90°C @ 2.4 bar)
Max. Flow Rate:	Bag1 20 m ³ /hr (88 gal/min) Bag2 40 m ³ /hr (176 gal/min)

RECOMMENDED CHANGEOUT

Differential Pressure:	35 psid (2.4 bar)
------------------------	-------------------

CHEMICAL COMPATIBILITY

CHEMICAL	Compatibility Rating
Water / Potable Liquids	4
Alkalis	4
Organic Solvents	3
Oils	2
Oxidizing Acids	1
Dilute inorganic Acids	4
Strong Inorganic Acids	4

0 = Not Recommended 1 = Poor 2 = Fair 3 = Good 4 = Excellent

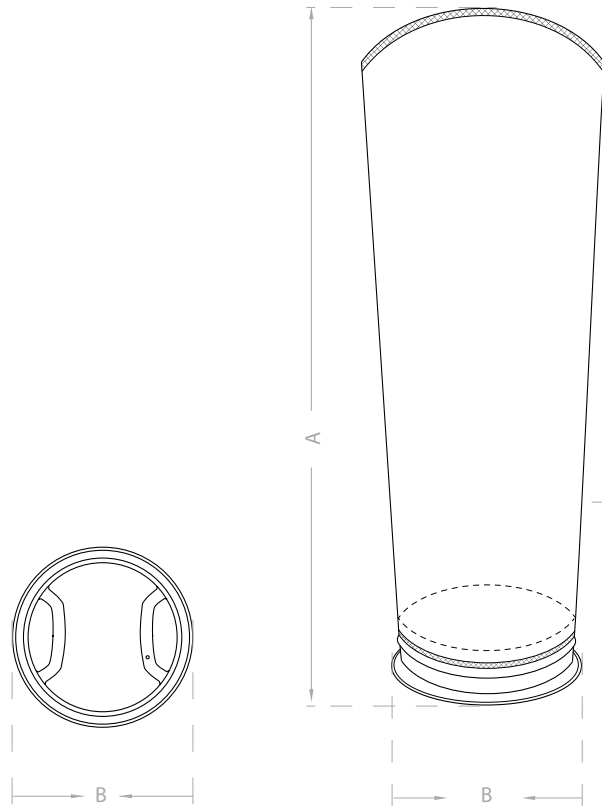

BAG1 / BAG2 SERIES DIMENSIONS

MODEL	A Length	B OD Diameter
BAG1	16.5"	7"
BAG2	32"	7"

MATERIALS OF CONSTRUCTION

Filter Media:	Polypropylene
Ring:	Polypropylene
Handle:	Polypropylene

DO NOT use with water that is microbiologically unsafe or of unknown quality without adequate disinfection before or after the system.

Copyright © 2019 HydroScientific., All Rights Reserved.



ABSOLUTE RATED PLEATED FILTERS

AR SERIES



HYDROSCIENTIFIC™ AR SERIES ABSOLUTE RATED PLEATED FILTERS are Beta 5000 Absolute rated filters. Made from 100% pure Polypropylene, HydroScientific AR Series Filters comply with USP XXIII and FDA CFR Title 21 for food and beverage applications.

HYDROSCIENTIFIC™ AR SERIES ABSOLUTE RATED PLEATED FILTERS offer a longer service life and contain no binders, adhesives or surfactant for wide compatibility of fluids. They combine exceptional solids holding capacity with precise micron ratings. Layered double sheets of media provide absolute particle retention and long service life.

HYDROSCIENTIFIC™ AR SERIES ABSOLUTE RATED PLEATED FILTERS are free of surfactants, detergents and anti-static agents. AR series filter cartridges do not impart any substances into water which are known to or can cause adverse health effects to humans.

AR SERIES - ABSOLUTE RATED PLEATED FILTER SPECIFICATIONS

	Part Number	Description	Micron Rating	O-Ring Material	End Cap Style	Case Quantity	Box Dimension (Inches)	Weight (lbs)	Weight (kgs)
10"	AR0020S01A	HydroScientific™ Absolute Rated Pleated Filters, 2.5" x 10"	0.2	SILICONE	222/FLAT	20	15" x 12" x 14"	17	7.71
	AR0020S51A	HydroScientific™ Absolute Rated Pleated Filters, 2.5" x 10"	0.2	SILICONE	222/FIN	20	15" x 12" x 14"	17	7.71
	AR0020SF1A	HydroScientific™ Absolute Rated Pleated Filters, 2.5" x 10"	0.2	SILICONE	DOE	20	15" x 12" x 14"	17	7.71
20"	AR0020S02A	HydroScientific™ Absolute Rated Pleated Filters, 2.5" x 20"	0.2	SILICONE	222/FLAT	20	15" x 12" x 23"	30	13.61
	AR0020S52A	HydroScientific™ Absolute Rated Pleated Filters, 2.5" x 20"	0.2	SILICONE	222/FIN	20	15" x 12" x 23"	30	13.61
	AR0020SF2A	HydroScientific™ Absolute Rated Pleated Filters, 2.5" x 20"	0.2	SILICONE	DOE	20	15" x 12" x 23"	30	13.61
30"	AR0020S03A	HydroScientific™ Absolute Rated Pleated Filters, 2.5" x 30"	0.2	SILICONE	222/FLAT	20	15" x 12" x 35"	43	19.50
	AR0020S53A	HydroScientific™ Absolute Rated Pleated Filters, 2.5" x 30"	0.2	SILICONE	222/FIN	20	15" x 12" x 35"	43	19.50
	AR0020SF3A	HydroScientific™ Absolute Rated Pleated Filters, 2.5" x 30"	0.2	SILICONE	DOE	20	15" x 12" x 35"	43	19.50
40"	AR0020S04A	HydroScientific™ Absolute Rated Pleated Filters, 2.5" x 40"	0.2	SILICONE	222/FLAT	20	15" x 12" x 44"	55	24.95
	AR0020S54A	HydroScientific™ Absolute Rated Pleated Filters, 2.5" x 40"	0.2	SILICONE	222/FIN	20	15" x 12" x 44"	55	24.95
	AR0020SF4A	HydroScientific™ Absolute Rated Pleated Filters, 2.5" x 40"	0.2	SILICONE	DOE	20	15" x 12" x 44"	55	24.95

ABSOLUTE RATED PLEATED FILTERS

AR SERIES



FEATURES

- Double layer structure, absolute rated.
- Thermal bonded end caps and connectors free of any binders.
- End connections fit most standard housings.
- FDA / USP Material Safety Compliance - All materials comply with FDA requirements for food and beverage contact per CFR Title 21 174.5, 177.1520 and 177.1630. All components meet USP Class VI Plastics.

RECOMMENDED CHANGEOUT

Differential Pressure: 35.6 psid (2.5 kg/cm²)

APPLICATIONS

- RO Pre-filtration
- DI Pre-filtration
- Cooling Tower
- Pharmacist
- Liquids of medium and low viscosity
- Food & Beverages
- Laboratory

OPERATIONAL DATA

Max. Pressure Drop: 68°F at 70 psi - 20°C at 4.9 kg/cm²
140°F at 40 psi - 60°C at 2.8 kg/cm²
203°F at 20 psi - 95°C at 1.4 kg/cm²

Max. Operating Temperature: 203 °F (95 °C)

ADDITIONAL FEATURES

Inner Diameter (ID): 1"
Outer Diameter (OD): 2.75"

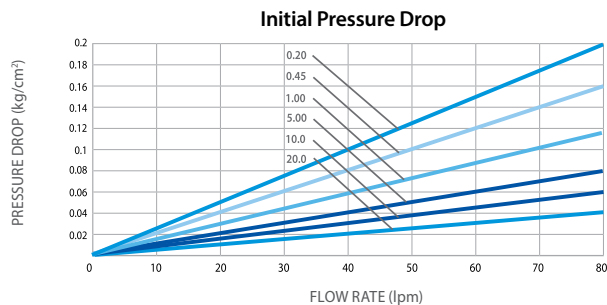

Copyright © 2019 HydroScientific., All Rights Reserved.

DISPLACES

Millipore: Polyguard - CN
Pall: HDC II Filter
Pall: Ultipleat Profile
Cuno: Poly Flow - G
Cuno: Polypro
Filterite: Poly - Fine II

MATERIALS OF CONSTRUCTION

Filter Media: Polypropylene
Outer Shell: Polypropylene
Core: Polypropylene
End Cap: Polypropylene
O-Ring: EPDM - (Buna-N, Viton, Silicone and Viton Encapsulado PFA options)

RETENTION EFFICIENCY (%)

Part Number	0.2 Micron	0.45 Micron	1.0 Micron	5.0 Micron	10.0 Micron	20.0 Micron
AR0020	> 99.9	> 99.9	> 99.9	> 99.9	> 99.9	> 99.9
AR0045	62.3	> 99.9	> 99.9	> 99.9	> 99.9	> 99.9
AR00100	30.2	73.9	> 99.9	> 99.9	> 99.9	> 99.9
AR00500	-	46.8	87.3	> 99.9	> 99.9	> 99.9
AR001000	-	-	53.9	81.5	> 99.9	> 99.9
AR002000	-	-	-	59.3	86.9	> 99.9

MODEL # GUIDE

Absolute Rated Pleated Filter O-Ring Material Length

AR 0020 S 01 A

Micron End Cap Pre Flush

LEGEND

<p>Length:</p> <p>1 = 10" 2 = 20" 3 = 30" 4 = 40"</p>	<p>O-Ring Material:</p> <p>E = EPDM (Black) N = Buna-N S = Silicone (Red) V = Viton T = Viton Encapsulated PFA</p>	<p>End Cap:</p> <p>F = Double Open Cap 0 = 222/Flat (SOE) 5 = 222/Fin (SOE) 6 = 226/Flat (SOE) 7 = 226/Fin (SOE) 8 = Spring/Open</p>
<p>Micron:</p> <p>0020 = 0.2 Micron 0045 = 0.45 Micron 0100 = 1 Micron 0500 = 5 Micron 1000 = 10 Micron 2000 = 20 Micron</p>	<p>Pre-Flush:</p> <p>B = Pre-flush with DI water A = Non pre-flush</p>	

F

0

5

6

7

8

End cap, special lengths and diameters available.



DELTA-PLUS FILTERS

DP SERIES



HYDROSCIENTIFIC™ DP SERIES DELTA - PLUS FILTERS

meet market needs for a pure Polypropylene depth filter with exceptional dirt holding capacity and performance. Delta-Plus cartridges are an outstanding value for industrial applications where long-life, low-pressure drop and high efficiency is required.

HYDROSCIENTIFIC™ DP SERIES DELTA - PLUS FILTERS

have continuous gradient pore structure which increases dust holding capacity. The surface of the cartridge is fiber fortified to prevent the release of micro fibers downstream. Manufactured of 100% pure Polypropylene for a wide range of process fluids.

HYDROSCIENTIFIC™ DP SERIES DELTA - PLUS FILTERS

are made with 100% pure polypropylene and are free of surfactants, detergents and anti-static agents. DP series filter cartridges do not impart any substances into water which are known to or can cause adverse health effects to humans.

DP SERIES DELTA - PLUS FILTER SPECIFICATIONS									
	Part Number	Description	Micron Rating	O-Ring Material	End Cap Style	Case Quantity	Box Dimension (Inches)	Weight (lbs)	Weight (kgs)
10"	DP001SX1000	HydroScientific™ Delta-Plus Filters, 2.5" x 10"	1	SILICONE	DOUBLE OPEN	40	12" x 10" x 20"	15	6.80
	DP001S51000	HydroScientific™ Delta-Plus Filters, 2.5" x 10"	1	SILICONE	222/FIN	40	12" x 10" x 21"	15	6.80
	DP001SF1000	HydroScientific™ Delta-Plus Filters, 2.5" x 10"	1	SILICONE	DOE	40	12" x 10" x 21"	15	6.80
20"	DP001SX2000	HydroScientific™ Delta-Plus Filters, 2.5" x 20"	1	SILICONE	DOUBLE OPEN	20	12" x 10" x 20"	15	6.80
	DP001S52000	HydroScientific™ Delta-Plus Filters, 2.5" x 20"	1	SILICONE	222/FIN	20	12" x 10" x 21"	15	6.80
	DP001SF2000	HydroScientific™ Delta-Plus Filters, 2.5" x 20"	1	SILICONE	DOE	20	12" x 10" x 21"	15	6.80
30"	DP001SX3000	HydroScientific™ Delta-Plus Filters, 2.5" x 30"	1	SILICONE	DOUBLE OPEN	20	12" x 10" x 30"	22	9.98
	DP001S53000	HydroScientific™ Delta-Plus Filters, 2.5" x 30"	1	SILICONE	222/FIN	20	12" x 10" x 34"	22	9.98
	DP001SF3000	HydroScientific™ Delta-Plus Filters, 2.5" x 30"	1	SILICONE	DOE	20	12" x 10" x 34"	22	9.98
40"	DP001SX4000	HydroScientific™ Delta-Plus Filters, 2.5" x 40"	1	SILICONE	DOUBLE OPEN	20	12" x 10" x 40"	30	13.61
	DP001S54000	HydroScientific™ Delta-Plus Filters, 2.5" x 40"	1	SILICONE	222/FIN	20	12" x 10" x 40"	30	13.61
	DP001SF4000	HydroScientific™ Delta-Plus Filters, 2.5" x 40"	1	SILICONE	DOE	20	12" x 10" x 40"	30	13.61

DELTA-PLUS FILTERS

DP SERIES



FEATURES

- Absolute ratings from 1 to 100 microns.
- Surface pore structure extends water flow to reduce pressure drop.
- Thermally bonded end caps and connectors free of any binders.
- FDA / USP Material Safety Compliance - All materials comply with FDA requirements for food and beverage contact per CFR Title 21 174.5, 177.1520 and 177.1630. All components meet USP Class VI Plastics.

MATERIALS OF CONSTRUCTION

Filter Media: Polypropylene
 End Cap: Polypropylene
 O-Ring / Gasket: EPDM - (Buna-N, Viton, Silicone and Viton Encapsulado PFA options)

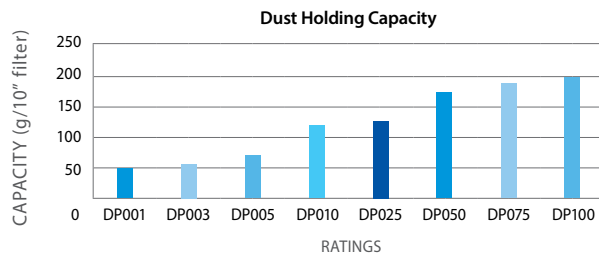

RETENTION EFFICIENCY (%)

Part Number	1 Micron	3 Micron	5 Micron	10 Micron	25 Micron	50 Micron	75 Micron	100 Micron
DP001	> 99.9	> 99.9	> 99.9	> 99.9	> 99.9	> 99.9	> 99.9	> 99.9
DP003	89.9	> 99.9	> 99.9	> 99.9	> 99.9	> 99.9	> 99.9	> 99.9
DP005	75.9	91.2	> 99.9	> 99.9	> 99.9	> 99.9	> 99.9	> 99.9
DP010	-	63.8	87.3	> 99.9	> 99.9	> 99.9	> 99.9	> 99.9
DP025	-	-	69.9	92.8	> 99.9	> 99.9	> 99.9	> 99.9
DP050	-	-	-	58.1	74.9	> 99.9	> 99.9	> 99.9
DP075	-	-	-	63.9	63.9	90.5	> 99.9	> 99.9
DP100	-	-	-	60.1	60.1	87.4	92.8	> 99.9

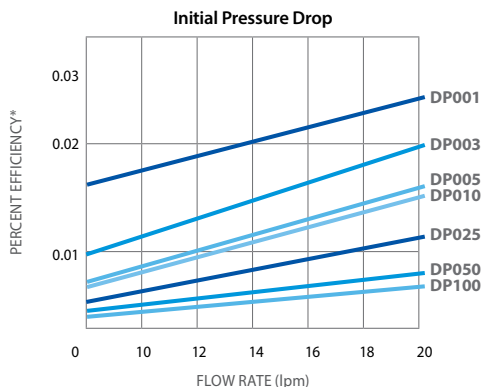

FLOW DETAIL

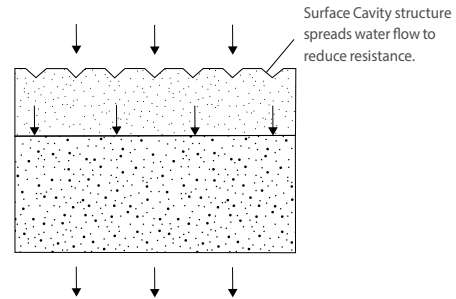

DISPLACES

Cuno: Deltaklean	Pentek: Polydepth
Cuno: Betapure	Millipore: Planargard Filter
Filterite: Nexis	Millipore: Polygard-CR
	Pall: Profile II Filter-RMF Style

OPERATIONAL DATA

Max. Pressure Drop: 100°F at 80 psi - 37°C at 5.6 kg/cm²
 150°F at 60 psi - 65°C at 4.2 kg/cm²
 180°F at 30 psi - 82°C at 2.1 kg/cm²

Max. Operating Temperature: 180 °F (82 °C)

RECOMMENDED CHANGEOUT

Differential Pressure: 30 psid (2.1 kg/cm²)

MODEL # GUIDE

Delta-Plus Cavity Filter O-Ring Material Length

DP 001 S X 1000

Micron Rating End Cap

LEGEND

Length: 1000 = 10" 2000 = 20" 3000 = 30" 4000 = 40"	O-Ring Material: E = EPDM (Black) N = Buna-N S = Silicone (Red) V = Viton T = Viton Encapsulated PFA	End Cap: X = Double Open F = Double Open End (DOE) 0 = 222/Flat (SOE) 5 = 222/Fin (SOE) 6 = 226/Flat (SOE) 7 = 226/Fin (SOE) 8 = Spring/Open
--	--	--

F	0	5	6	7	8

End cap, special lengths and diameters available.



Tested and certified by NSF International to ANSI/NSF Standard 42 for material requirements only.

SEDIMENT DEPTH CARTRIDGES

SDX FLEX SERIES

HYDROSCIENTIFIC™ SDX FLEX SERIES CARTRIDGES

are comprised of special matrix spun polypropylene layer designed to trap coarse and fine particles which increases reliability and service life over conventional cartridges. Utilizing the Flex Matrix technology, SDX Flex Series Cartridges do not utilize binders, anti-static agents or surfactants to produce an ideal surface filtration area.

HYDROSCIENTIFIC™ SDX FLEX SERIES CARTRIDGES

are produced with a precise and even matrix of polypropylene fibers which results in no foaming and are anti-static. Made with FDA approved Polypropylene, SDX Flex Series Cartridges are extremely resistant to chemicals and are safe to use in a wide range of applications. SDX Flex Series Cartridges are NSF/ANSI Certified to Standard 42 and comply with FDA CFR 21 guidelines.

SDX FLEX SERIES - 2.5" SEDIMENT DEPTH CARTRIDGE SPECIFICATIONS

	Part Number	Description	Micron Rating	Case Quantity	Box Dimension (Inches)	Weight (lbs)	Weight (kgs)
10"	SDX-25-10-0.5	2.5" x 9 7/8"	0.5	40	13" x 11" x 21"	14	6.35
	SDX-25-1001	2.5" x 9 7/8"	1	40	13" x 11" x 21"	14	6.35
	SDX-25-1005	2.5" x 9 7/8"	5	40	13" x 11" x 21"	14	6.35
	SDX-25-1010	2.5" x 9 7/8"	10	40	13" x 11" x 21"	14	6.35
	SDX-25-1020	2.5" x 9 7/8"	20	40	13" x 11" x 21"	14	6.35
	SDX-25-1050	2.5" x 9 7/8"	50	40	13" x 11" x 21"	14	6.35
	SDX-25-10100	2.5" x 9 7/8"	100	40	13" x 11" x 21"	14	6.35
20"	SDX-25-20-0.5	2.5" x 20"	0.5	20	13" x 11" x 21"	14	6.35
	SDX-25-2001	2.5" x 20"	1	20	13" x 11" x 21"	14	6.35
	SDX-25-2005	2.5" x 20"	5	20	13" x 11" x 21"	14	6.35
	SDX-25-2010	2.5" x 20"	10	20	13" x 11" x 21"	14	6.35
	SDX-25-2020	2.5" x 20"	20	20	13" x 11" x 21"	14	6.35
	SDX-25-2050	2.5" x 20"	50	20	13" x 11" x 21"	14	6.35
29"	SDX-25-29141	2.5" x 29 1/4"	1	20	13" x 11" x 31"	17	7.71
	SDX-25-29145	2.5" x 29 1/4"	5	20	13" x 11" x 31"	17	7.71
30"	SDX-25-3001	2.5" x 30"	1	20	13" x 11" x 31"	18	8.16
	SDX-25-3005	2.5" x 30"	5	20	13" x 11" x 31"	18	8.16
	SDX-25-3010	2.5" x 30"	10	20	13" x 11" x 31"	18	8.16
	SDX-25-3025	2.5" x 30"	25	20	13" x 11" x 31"	18	8.16
	SDX-25-3050	2.5" x 30"	50	20	13" x 11" x 31"	18	8.16
	SDX-25-3075	2.5" x 30"	75	20	13" x 11" x 31"	18	8.16
	SDX-25-30100	2.5" x 30"	100	20	13" x 11" x 31"	18	8.16
39"	SDX-25-3905	2.5" x 39"	5	20	13" x 11" x 41"	22	9.97
40"	SDX-25-4001	2.5" x 40"	1	20	13" x 11" x 41"	23	10.43
	SDX-25-4005	2.5" x 40"	5	20	13" x 11" x 41"	23	10.43
	SDX-25-4010	2.5" x 40"	10	20	13" x 11" x 41"	23	10.43
	SDX-25-4025	2.5" x 40"	25	20	13" x 11" x 41"	23	10.43
	SDX-25-4050	2.5" x 40"	50	20	13" x 11" x 41"	23	10.43
	SDX-25-4075	2.5" x 40"	75	20	13" x 11" x 41"	23	10.43
	SDX-25-40100	2.5" x 40"	100	20	13" x 11" x 41"	23	10.43
50"	SDX-25-5005	2.5" x 50"	5	20	13" x 11" x 51"	27	12.25

SEDIMENT DEPTH CARTRIDGES

SDX FLEX SERIES



SDX FLEX SERIES - 4.5" SEDIMENT DEPTH CARTRIDGE SPECIFICATIONS							
	Part Number	Description	Micron Rating	Case Quantity	Box Dimension (Inches)	Weight (lbs)	Weight (kgs)
10"	SDX-45-1001	4.5" x 9 7/8"	1	12	10" x 15" x 21"	15	6.8
	SDX-45-1005	4.5" x 9 7/8"	5	12	10" x 15" x 21"	15	6.8
	SDX-45-1010	4.5" x 9 7/8"	10	12	10" x 15" x 21"	15	6.8
	SDX-45-1020	4.5" x 9 7/8"	20	12	10" x 15" x 21"	15	6.8
	SDX-45-1050	4.5" x 9 7/8"	50	12	10" x 15" x 21"	15	6.8
20"	SDX-45-2001	4.5" x 20"	1	6	10" x 15" x 21"	15	6.8
	SDX-45-2005	4.5" x 20"	5	6	10" x 15" x 21"	15	6.8
	SDX-45-2010	4.5" x 20"	10	6	10" x 15" x 21"	15	6.8
	SDX-45-2020	4.5" x 20"	20	6	10" x 15" x 21"	15	6.8
	SDX-45-2050	4.5" x 20"	50	6	10" x 15" x 21"	15	6.8

APPLICATIONS

- Ink
- Paint
- Plating
- Ultra Filtration
- Chemical liquid
- Reverse Osmosis
- Food & Beverage
- Electronic Industry

MAXIMUM DIFFERENTIAL PRESSURE

15 psid at 175 °F (1.0 bar at 80 °C)
 25 psid at 140 °F (1.7 bar at 60 °C)
 60 psid at 68 °F (4.13 bar at 20 °C)

OPERATIONAL DATA

Max. Operating Temperature: 145 °F (63 °C)
 Max. Pressure Drop: 69 °F (20 °C) at 46.4 psi (3.2 kg/cm²)
 Rec. Replaceable Pressure Drop: 21.75 psi (1.5 kg/cm²)
 Temperature Range: 40 °F to 145 °F (4.4 °C to 79.4 °C)
 Max. Flow: 2-8 gpm**
 **Depending on micron rating.

MATERIALS OF CONSTRUCTION

Filter Media: 100% Polypropylene

4.5" DIAMETER SPECIFICATIONS

	Part Number	Initial ΔP (psi) at Flow Rate (gpm)
10"	SDX-45-1001	1 psi at 10 gpm
	SDX-45-1005	1 psi at 10 gpm
	SDX-45-1010	1 psi at 10 gpm
	SDX-45-1020	1 psi at 10 gpm
	SDX-45-1050	1 psi at 10 gpm
20"	SDX-45-2001	1 psi at 20 gpm
	SDX-45-2005	1 psi at 20 gpm
	SDX-45-2010	1 psi at 20 gpm
	SDX-45-2020	1 psi at 20 gpm
	SDX-45-2050	1 psi at 20 gpm

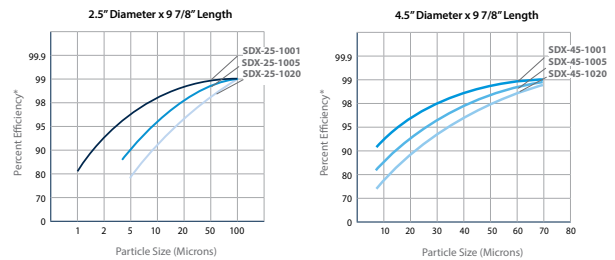

MODEL # GUIDE

Sediment Depth Cartridge Length O-Ring Material

SDX-25-4001-S5

Outside Diameter Micron End Cap

LEGEND

Outside Diameter:	Micron:	End Cap:
25 = 2.5"	0.5 = 0.5 Micron	No symbol = Double Open
45 = 4.5"	01 = 1 Micron	F = Double Open Cap
10 = 9 7/8"	05 = 5 Micron	0 = 222/Flat (SOE)
20 = 20"	10 = 10 Micron	5 = 222/Fin (SOE)
30 = 30"	20 = 20 Micron	6 = 226/Flat (SOE)
40 = 40"	25 = 25 Micron	7 = 226/Fin (SOE)
50 = 50"	50 = 50 Micron	8 = Spring/Open
	75 = 75 Micron	
	100 = 100 Micron	

O-Ring Material: E = EPDM (Black)
 N = Buna-N
 S = Silicone (Red)
 V = Viton

F

0

5

6

7

8

End cap, special lengths and diameters available.

RECOMMENDED CHANGEOUT

Differential Pressure: 21.75 psi (1.5 kg/cm²)

FDA / USP Material Safety Compliance - All materials comply with FDA requirements for food and beverage contact per CFR Title 21 174.5, 177.1520 and 177.1630. All components meet USP Class VI Plastics.

*WARNING: Do not use with water that is microbiologically unsafe or of unknown quality without adequate disinfection before or after the system.



STRING WOUND CARTRIDGES

SWX SERIES



HYDROSCIENTIFIC™ SWX SERIES STRING WOUND CARTRIDGES

a cost effective solution for the reduction of sand, silt, rust, dirt and scale particles. Made from 100% Polypropylene cord, SWX Series String Wound Cartridges can withstand temperatures of up to 165°F (73.9°C). SWX Series filter cartridges are suitable for a variety of applications including residential and commercial applications using both municipal and well water. Different wound patterns for different micron ratings ensure that you are getting the right product for the right application.

HYDROSCIENTIFIC™ SWX SERIES STRING WOUND CARTRIDGES

are made with 100% pure polypropylene and are free of surfactants, detergents and anti-static agents. SWX series filter cartridges do not impart any substances into water which are known to or can cause adverse health effects to humans. SWX polypropylene media complies with the appropriate U.S. Food and Drug Administration guidelines, as outlined in the Code of Federal regulations, Title 21, Sections 177.1520 (a), (1) and Section 177.1520 (c), (1.1).

SWX SERIES - 2.5" STRING WOUND CARTRIDGE SPECIFICATIONS								
	Part Number	Description	Material	Micron Rating	Case Quantity	Box Dimension (Inches)	Weight (lbs)	Weight (kgs)
10"	SWX-25-10-0.5	2.5" x 10"	PP	0.5	40	13" x 11" x 21"	17	7.71
	SWX-25-1001	2.5" x 10"	PP	1	40	13" x 11" x 21"	17	7.71
	SWX-25-1005	2.5" x 10"	PP	5	40	13" x 11" x 21"	17	7.71
	SWX-25-1010	2.5" x 10"	PP	10	40	13" x 11" x 21"	17	7.71
	SWX-25-1020	2.5" x 10"	PP	20	40	13" x 11" x 21"	17	7.71
	SWX-25-1030	2.5" x 10"	PP	30	40	13" x 11" x 21"	17	7.71
	SWX-25-1050	2.5" x 10"	PP	50	40	13" x 11" x 21"	17	7.71
20"	SWX-25-10100	2.5" x 10"	PP	100	40	13" x 11" x 21"	17	7.71
	SWX-25-20-0.5	2.5" x 20"	PP	0.5	20	13" x 11" x 21"	17	7.71
	SWX-25-2001	2.5" x 20"	PP	1	20	13" x 11" x 21"	17	7.71
	SWX-25-2005	2.5" x 20"	PP	5	20	13" x 11" x 21"	17	7.71
	SWX-25-2010	2.5" x 20"	PP	10	20	13" x 11" x 21"	17	7.71
	SWX-25-2020	2.5" x 20"	PP	20	20	13" x 11" x 21"	17	7.71
	SWX-25-2030	2.5" x 20"	PP	30	20	13" x 11" x 21"	17	7.71
30"	SWX-25-2050	2.5" x 20"	PP	50	20	13" x 11" x 21"	17	7.71
	SWX-25-20100	2.5" x 20"	PP	100	20	13" x 11" x 21"	17	7.71
	SWX-25-30-0.5	2.5" x 30"	PP	0.5	20	13" x 11" x 31"	28	12.70
	SWX-25-3001	2.5" x 30"	PP	1	20	13" x 11" x 31"	28	12.70
	SWX-25-3005	2.5" x 30"	PP	5	20	13" x 11" x 31"	28	12.70
	SWX-25-3010	2.5" x 30"	PP	10	20	13" x 11" x 31"	28	12.70
	SWX-25-3020	2.5" x 30"	PP	20	20	13" x 11" x 31"	28	12.70
40"	SWX-25-3030	2.5" x 30"	PP	30	20	13" x 11" x 31"	28	12.70
	SWX-25-3050	2.5" x 30"	PP	50	20	13" x 11" x 31"	28	12.70
	SWX-25-30100	2.5" x 30"	PP	100	20	13" x 11" x 31"	28	12.70
	SWX-25-40-0.5	2.5" x 40"	PP	0.5	20	13" x 11" x 41"	38	17.23
	SWX-25-4001	2.5" x 40"	PP	1	20	13" x 11" x 41"	38	17.23
	SWX-25-4005	2.5" x 40"	PP	5	20	13" x 11" x 41"	38	17.23
	SWX-25-4010	2.5" x 40"	PP	10	20	13" x 11" x 41"	38	17.23
	SWX-25-4020	2.5" x 40"	PP	20	20	13" x 11" x 41"	38	17.23
	SWX-25-4030	2.5" x 40"	PP	30	20	13" x 11" x 41"	38	17.23
	SWX-25-4050	2.5" x 40"	PP	50	20	13" x 11" x 41"	38	17.23
	SWX-25-40100	2.5" x 40"	PP	100	20	13" x 11" x 41"	38	17.23

*50" and other Special lengths available upon request.

PP = POLYPROPYLENE

STRING WOUND CARTRIDGES

SWX SERIES



SWX SERIES - 4.5" STRING WOUND CARTRIDGE SPECIFICATIONS								
	Part Number	Description	Material	Micron Rating	Case Quantity	Box Dimension (Inches)	Weight (lbs)	Weight (kgs)
10"	SWX-45-10-0.5	4.5" x 10"	PP	0.5	12	14" x 10" x 21"	18	8.16
	SWX-45-1001	4.5" x 10"	PP	1	12	14" x 10" x 21"	18	8.16
	SWX-45-1005	4.5" x 10"	PP	5	12	14" x 10" x 21"	18	8.16
	SWX-45-1010	4.5" x 10"	PP	10	12	14" x 10" x 21"	18	8.16
	SWX-45-1020	4.5" x 10"	PP	20	12	14" x 10" x 21"	18	8.16
	SWX-45-1030	4.5" x 10"	PP	30	12	14" x 10" x 21"	18	8.16
	SWX-45-1050	4.5" x 10"	PP	50	12	14" x 10" x 21"	18	8.16
20"	SWX-45-20-0.5	4.5" x 20"	PP	0.5	6	14" x 10" x 21"	18	8.16
	SWX-45-2001	4.5" x 20"	PP	1	6	14" x 10" x 21"	18	8.16
	SWX-45-2005	4.5" x 20"	PP	5	6	14" x 10" x 21"	18	8.16
	SWX-45-2010	4.5" x 20"	PP	10	6	14" x 10" x 21"	18	8.16
	SWX-45-2020	4.5" x 20"	PP	20	6	14" x 10" x 21"	18	8.16
	SWX-45-2030	4.5" x 20"	PP	30	6	14" x 10" x 21"	18	8.16
	SWX-45-2050	4.5" x 20"	PP	50	6	14" x 10" x 21"	18	8.16
	SWX-45-20100	4.5" x 20"	PP	100	6	14" x 10" x 21"	18	8.16

*Special lengths and diameter available.

WARNING: Do not use with water that is microbiologically unsafe or of unknown quality without adequate disinfection before or after the system.

PP = POLYPROPYLENE

FEATURES

- Manufactured from 100% Polypropylene Cord.
- Reduces sand, silt, rust and scale particles.
- High dirt holding capacity.
- FDA / USP Material Safety Compliance - All materials comply with FDA requirements for food and beverage contact per CFR Title 21 174.5, 177.1520 and 177.1630. All components meet USP Class VI Plastics.

MATERIALS OF CONSTRUCTION

Filter Media: Polypropylene Fiber Cord

Core: Polypropylene

OPERATIONAL DATA

Temperature Range: 40 °F to 165 °F (4.4 °C to 73.9 °C)

RECOMMENDED CHANGEOUT

30 psi maximum - Dirty

10-15 psi optimum - Change out

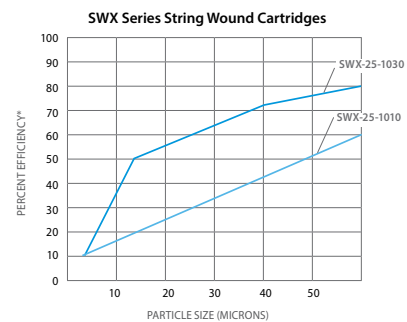

MODEL # GUIDE

String Wound Cartridge Length O-Ring Material

SWX-25-4001-S5

Outside Diameter Micron End Cap

LEGEND

Outside Diameter:	25 = 2.5"	45 = 4.5"	10 = 9 1/8"	20 = 20"	30 = 30"	40 = 40"	50 = 50"
Length:	01 = 1 Micron	05 = 5 Micron	10 = 10 Micron	20 = 20 Micron	30 = 30 Micron	50 = 50 Micron	100 = 100 Micron
End Cap:	No symbol = Double Open	F = Double Open Cap	0 = 222/Flat (SOE)	5 = 222/Fin (SOE)	6 = 226/Flat (SOE)	7 = 226/Fin (SOE)	8 = Spring/Open
O-Ring Material:	E = EPDM (Black)	N = Buna-N	S = Silicone (Red)	V = Viton			

F

0

5

6

7

8

End cap, special lengths and diameters available.



POLYESTER PLEATED CARTRIDGES

SPX SERIES



HYDROSCIENTIFIC™ SPX SERIES POLYESTER PLEATED CARTRIDGES are manufactured from durable polyester to provide you with a superior pleated cartridge that is washable and reusable. The Polyester media is pleated around a Polypropylene core for added strength and the ends are immersed in a thermosetting Vinyl Plastisol which fuses the three components together forming a unified end cap and gasket. The cartridges are bacteria and chemical resistant and provide great dirt holding capacity to extend the time between cartridge change outs.

HYDROSCIENTIFIC™ SPX SERIES POLYESTER PLEATED CARTRIDGES are made with 100% pure polypropylene and are free of surfactants, detergents and anti-static agents. SPX series filter cartridges do not impart any substances into water which are known to or can cause adverse health effects to humans.

SPX SERIES - 2.75" SEDIMENT PLEATED CARTRIDGE SPECIFICATIONS

	Part Number	Description	Micron Rating	Case Quantity	Box Dimension (Inches)	Weight (lbs)	Weight (kgs)
10"	SPX-275-100.35	2.75" x 9.75"	0.35	40	13" x 11" x 21"	14	6.35
	SPX-275-1001	2.75" x 9.75"	1	40	13" x 11" x 21"	14	6.35
	SPX-275-1001A	2.75" x 9.75"	1	40	13" x 11" x 21"	14	6.35
	SPX-275-1005	2.75" x 9.75"	5	40	13" x 11" x 21"	14	6.35
	SPX-275-1010	2.75" x 9.75"	10	40	13" x 11" x 21"	14	6.35
	SPX-275-1020	2.75" x 9.75"	20	40	13" x 11" x 21"	14	6.35
	SPX-275-1030	2.75" x 9.75"	30	40	13" x 11" x 21"	14	6.35
	SPX-275-1050	2.75" x 9.75"	50	40	13" x 11" x 21"	14	6.35
19.5"	SPX-275-10100	2.75" x 9.75"	100	40	13" x 11" x 21"	14	6.35
	SPX-275-1950.35	2.75" x 19.5"	0.35	20	13" x 11" x 21"	13.5	6.12
	SPX-275-19501	2.75" x 19.5"	1	20	13" x 11" x 21"	13.5	6.12
	SPX-275-19501A	2.75" x 19.5"	1	20	13" x 11" x 21"	13.5	6.12
	SPX-275-19505	2.75" x 19.5"	5	20	13" x 11" x 21"	13.5	6.12
	SPX-275-19510	2.75" x 19.5"	10	20	13" x 11" x 21"	13.5	6.12
	SPX-275-19520	2.75" x 19.5"	20	20	13" x 11" x 21"	13.5	6.12
	SPX-275-19530	2.75" x 19.5"	30	20	13" x 11" x 21"	13.5	6.12
20"	SPX-275-19550	2.75" x 19.5"	50	20	13" x 11" x 21"	13.5	6.12
	SPX-275-195100	2.75" x 19.5"	100	20	13" x 11" x 21"	13.5	6.12
	SPX-275-200.35	2.75" x 20"	0.35	20	13" x 11" x 21"	14	6.35
	SPX-275-2001	2.75" x 20"	1	20	13" x 11" x 21"	14	6.35
	SPX-275-2001A	2.75" x 20"	1	20	13" x 11" x 21"	14	6.35
	SPX-275-2005	2.75" x 20"	5	20	13" x 11" x 21"	14	6.35
	SPX-275-2010	2.75" x 20"	10	20	13" x 11" x 21"	14	6.35
	SPX-275-2020	2.75" x 20"	20	20	13" x 11" x 21"	14	6.35
	SPX-275-2030	2.75" x 20"	30	20	13" x 11" x 21"	14	6.35
	SPX-275-2050	2.75" x 20"	50	20	13" x 11" x 21"	14	6.35
	SPX-275-20100	2.75" x 20"	100	20	13" x 11" x 21"	14	6.35

POLYESTER PLEATED CARTRIDGES



SPX SERIES

SPX SERIES - 2.75" SEDIMENT PLEATED CARTRIDGE SPECIFICATIONS							
	Part Number	Description	Micron Rating	Case Quantity	Box Dimension (Inches)	Weight (lbs)	Weight (kgs)
29.25"	SPX-275-292.35	2.75" x 29.25"	0.35	20	13" x 11" x 31"	17.55	7.96
	SPX-275-29201	2.75" x 29.25"	1	20	13" x 11" x 31"	17.55	7.96
	SPX-275-29201A	2.75" x 29.25"	1	20	13" x 11" x 31"	17.55	7.96
	SPX-275-29205	2.75" x 29.25"	5	20	13" x 11" x 31"	17.55	7.96
	SPX-275-29210	2.75" x 29.25"	10	20	13" x 11" x 31"	17.55	7.96
	SPX-275-29220	2.75" x 29.25"	20	20	13" x 11" x 31"	17.55	7.96
	SPX-275-29230	2.75" x 29.25"	30	20	13" x 11" x 31"	17.55	7.96
	SPX-275-29250	2.75" x 29.25"	50	20	13" x 11" x 31"	17.55	7.96
SPX-275-292100	2.75" x 29.25"	100	20	13" x 11" x 31"	17.55	7.96	
30"	SPX-275-300.35	2.75" x 30"	0.35	20	13" x 11" x 31"	18	8.16
	SPX-275-3001	2.75" x 30"	1	20	13" x 11" x 31"	18	8.16
	SPX-275-3001A	2.75" x 30"	1	20	13" x 11" x 31"	18	8.16
	SPX-275-3005	2.75" x 30"	5	20	13" x 11" x 31"	18	8.16
	SPX-275-3010	2.75" x 30"	10	20	13" x 11" x 31"	18	8.16
	SPX-275-3020	2.75" x 30"	20	20	13" x 11" x 31"	18	8.16
	SPX-275-3030	2.75" x 30"	30	20	13" x 11" x 31"	18	8.16
	SPX-275-3050	2.75" x 30"	50	20	13" x 11" x 31"	18	8.16
SPX-275-30100	2.75" x 30"	100	20	13" x 11" x 31"	18	8.16	
39"	SPX-275-390.35	2.75" x 39"	0.35	20	13" x 11" x 41"	22.4	10.16
	SPX-275-3901	2.75" x 39"	1	20	13" x 11" x 41"	22.4	10.16
	SPX-275-3901A	2.75" x 39"	1	20	13" x 11" x 41"	22.4	10.16
	SPX-275-3905	2.75" x 39"	5	20	13" x 11" x 41"	22.4	10.16
	SPX-275-3910	2.75" x 39"	10	20	13" x 11" x 41"	22.4	10.16
	SPX-275-3920	2.75" x 39"	20	20	13" x 11" x 41"	22.4	10.16
	SPX-275-3930	2.75" x 39"	30	20	13" x 11" x 41"	22.4	10.16
	SPX-275-3950	2.75" x 39"	50	20	13" x 11" x 41"	22.4	10.16
SPX-275-39100	2.75" x 39"	100	20	13" x 11" x 41"	22.4	10.16	
40"	SPX-275-400.35	2.75" x 40"	0.35	20	13" x 11" x 41"	23	10.43
	SPX-275-4001	2.75" x 40"	1	20	13" x 11" x 41"	23	10.43
	SPX-275-4001A	2.75" x 40"	1	20	13" x 11" x 41"	23	10.43
	SPX-275-4005	2.75" x 40"	5	20	13" x 11" x 41"	23	10.43
	SPX-275-4010	2.75" x 40"	10	20	13" x 11" x 41"	23	10.43
	SPX-275-4020	2.75" x 40"	20	20	13" x 11" x 41"	23	10.43
	SPX-275-4030	2.75" x 40"	30	20	13" x 11" x 41"	23	10.43
	SPX-275-4050	2.75" x 40"	50	20	13" x 11" x 41"	23	10.43
SPX-275-40100	2.75" x 40"	100	20	13" x 11" x 41"	23	10.43	

SPX SERIES - 4.5" SEDIMENT PLEATED CARTRIDGE SPECIFICATIONS							
	Part Number	Description	Micron Rating	Case Quantity	Box Dimension (Inches)	Weight (lbs)	Weight (kgs)
10"	SPX-45-100.2A	4.5" x 9.75"	0.2	12	14" x 10" x 21"	12	5.44
	SPX-45-100.35	4.5" x 9.75"	0.35	12	14" x 10" x 21"	12	5.44
	SPX-45-1001	4.5" x 9.75"	1	12	14" x 10" x 21"	12	5.44
	SPX-45-1001A	4.5" x 9.75"	1	12	14" x 10" x 21"	12	5.44
	SPX-45-1005	4.5" x 9.75"	5	12	14" x 10" x 21"	12	5.44
	SPX-45-1010	4.5" x 9.75"	10	12	14" x 10" x 21"	12	5.44
	SPX-45-1020	4.5" x 9.75"	20	12	14" x 10" x 21"	12	5.44
	SPX-45-1030	4.5" x 9.75"	30	12	14" x 10" x 21"	12	5.44
	SPX-45-1050	4.5" x 9.75"	50	12	14" x 10" x 21"	12	5.44
	SPX-45-10100	4.5" x 9.75"	100	12	14" x 10" x 21"	12	5.44
20"	SPX-45-200.35	4.5" x 20"	0.35	6	14" x 10" x 21"	12	5.44
	SPX-45-2001	4.5" x 20"	1	6	14" x 10" x 21"	12	5.44
	SPX-45-2001A	4.5" x 20"	1	6	14" x 10" x 21"	12	5.44
	SPX-45-2005	4.5" x 20"	5	6	14" x 10" x 21"	12	5.44
	SPX-45-2010	4.5" x 20"	10	6	14" x 10" x 21"	12	5.44
	SPX-45-2020	4.5" x 20"	20	6	14" x 10" x 21"	12	5.44
	SPX-45-2030	4.5" x 20"	30	6	14" x 10" x 21"	12	5.44
	SPX-45-2050	4.5" x 20"	50	6	14" x 10" x 21"	12	5.44
SPX-45-20100	4.5" x 20"	100	6	14" x 10" x 21"	12	5.44	

*WARNING: Do not use with water that is microbiologically unsafe or of unknown quality without adequate disinfection before or after the system.



POLYESTER PLEATED CARTRIDGES

SPX SERIES

SPX SERIES - 2.75" FLOW RATES							
Microns	2.75" x 10"	2.75" x 19.5"	2.75" x 20"	2.75" x 29.25"	2.75" x 30"	2.75" x 39"	2.75" x 40"
1	4	8	8	25	25	25	25
5	7	14	14	25	25	25	25
10	7	14	14	25	25	25	25
20	8	16	16	25	25	25	25
30	8	16	16	25	25	25	25
50	10	20	20	30	30	40	40
100	12	24	24	35	35	46	46

SPX SERIES - 4.5" FLOW RATES		
Microns	4.5" x 10"	4.5" x 20"
1	15	30
5	20	40
10	20	40
20	20	40
30	20	40
50	20	40
100	25	50

Flow Rates in gpm.

WARNING: Do not use with water that is microbiologically unsafe or of unknown quality without adequate disinfection before or after the system.

FEATURES

- Manufactured from durable Polyester.
- Made with FDA CFR 21 approved material.
- Bacteria and chemical resistant.
- Washable and reusable.
- FDA / USP Material Safety Compliance - All materials comply with FDA requirements for food and beverage contact per CFR Title 21 174.5, 177.1520 and 177.1630. All components meet USP Class VI Plastics.

OPERATIONAL DATA

Temperature Range: 40° F to 125° F (4.4° C to 51.7° C)

MATERIALS OF CONSTRUCTION

Filter Media: Non-woven Polyester
 End Caps: Vinyl Plastisol
 Core: Polypropylene

RECOMMENDED CHANGEOUT

Differential Pressure: 30 psid (2.07 bar)

SPX Performance

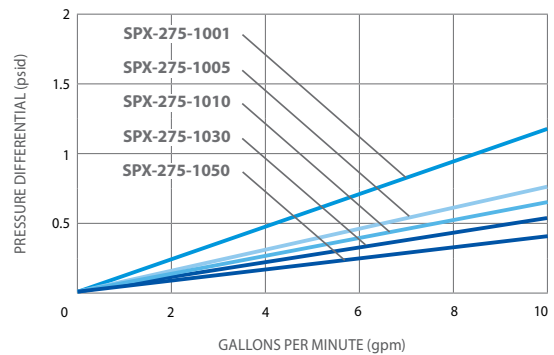

SPX Performance

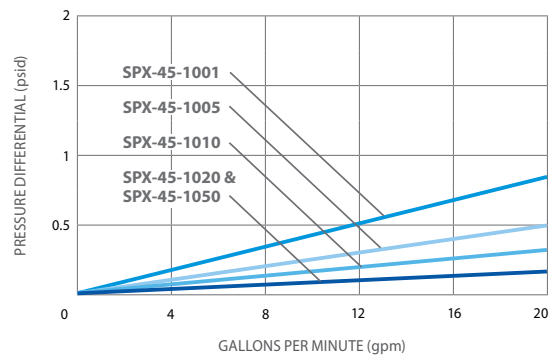

MODEL # GUIDE

Sediment Pleated Cartridge Length Retention Rating

SPX-45-100.2A

Outside Diameter Micron

LEGEND

Outside Diameter: 275 = 2.75"	Micron: 0.2 = 0.2 Micron	Retention Rating: A = Absolute
45 = 4.5"	0.35 = 0.35 Micron	
10 = 934"	01 = 1 Micron	
19 = 19.5"	05 = 5 Micron	
20 = 20"	10 = 10 Micron	
292 = 29.25"	20 = 20 Micron	
30 = 30"	30 = 30 Micron	
39 = 39"	50 = 50 Micron	
40 = 40"	100 = 100 Micron	





STAINLESS STEEL FILTER HOUSINGS

SC SERIES



HYDROSCIENTIFIC SCICLONE™ SERIES SS FILTER HOUSING provide an exceptional performance housing design that helps separate dense solids prior to water passing through the filter cartridge. This SCICLONIC™ design delivers extended filter life, low cost operation, increased dirt holding capacity and reduced maintenance costs.

HYDROSCIENTIFIC SCICLONE™ SERIES SS FILTER HOUSING come with Stainless Steel standpipes as a standard feature and through their SCICLONIC™ radial flow water entry, water enters the housing to create a cyclonic effect to prevent air entrapment and force water more effectively through the cartridges pleated filter media.



SC SCICLONE™ SERIES - 304SS SWING BOLT JUMBO FILTER HOUSING SPECIFICATIONS

Part Number	Description	Ports (In/Out)	Drains (FNPT)	Vents (FNPT)	Gauge Port	Swing Arm	Max. Flow (gpm)	Max. Flow (lpm)	Max. Flow (m ³ /hr)
SC40SB	HydroScientific Sciclone™ SB 40 Single Jumbo Filter Housing, ML, EP	2" FL	3/4"	1/2"	1/4"	-	50	189	12
SC90SB	HydroScientific Sciclone™ SB 90 Single Jumbo Filter Housing, ML, EP	2" FL	3/4"	1/2"	1/4"	-	100	378	24
SC170SB	HydroScientific Sciclone™ SB 170 Single Jumbo Filter Housing, ML, EP	2" FL	3/4"	1/2"	1/4"	-	150	568	36
SC170SB-3	HydroScientific Sciclone™ SB 3 x 170 Multi Jumbo Filter Housing, ML, EP	4" FL	1 1/2"	1/2"	1/2"	-	450	1703	102
SC170SB-4	HydroScientific Sciclone™ SB 4 x 170 Multi Jumbo Filter Housing, ML, EP	6" FL	1 1/2"	1/2"	1/2"	-	600	2272	144
SC170SB-5	HydroScientific Sciclone™ SB 5 x 170 Multi Jumbo Filter Housing, ML, EP	6" FL	1 1/2"	1/2"	1/2"	-	750	2839	170
SC170SB-8	HydroScientific Sciclone™ SB 8 x 170 Multi Jumbo Filter Housing, ML, GB	6" FL	1 1/2"	1/2"	1/2"	-	1200	4542	272
SC170SB-12	HydroScientific Sciclone™ SB 12 x 170 Multi Jumbo Filter Housing, ML, GB	12" FL	1 1/2"	1/2"	1/2"	✓	1800	6816	432
SC170SB-16	HydroScientific Sciclone™ SB 16 x 170 Multi Jumbo Filter Housing, ML, GB	12" FL	2"	1/2"	1/2"	✓	2400	9088	576

SC SCICLONE™ SERIES - 316SS SWING BOLT JUMBO FILTER HOUSING SPECIFICATIONS

Part Number	Description	Ports (In/Out)	Drains (FNPT)	Vents (FNPT)	Gauge Port	Swing Arm	Max. Flow (gpm)	Max. Flow (lpm)	Max. Flow (m ³ /hr)
SC40SB-316	HydroScientific Sciclone™ SB 40 Single Jumbo Filter Housing, ML, EP	2" FL	3/4"	1/2"	1/4"	-	50	189	12
SC90SB-316	HydroScientific Sciclone™ SB 90 Single Jumbo Filter Housing, ML, EP	2" FL	3/4"	1/2"	1/4"	-	100	378	24
SC170SB-316	HydroScientific Sciclone™ SB 170 Single Jumbo Filter Housing, ML, EP	2" FL	3/4"	1/2"	1/4"	-	150	568	36
SC170SB-3-316	HydroScientific Sciclone™ SB 3 x 170 Multi Jumbo Filter Housing, ML, EP	4" FL	1 1/2"	1/2"	1/2"	-	450	1703	102
SC170SB-4-316	HydroScientific Sciclone™ SB 4 x 170 Multi Jumbo Filter Housing, ML, EP	6" FL	1 1/2"	1/2"	1/2"	-	600	2272	144
SC170SB-5-316	HydroScientific Sciclone™ SB 5 x 170 Multi Jumbo Filter Housing, ML, EP	6" FL	1 1/2"	1/2"	1/2"	-	750	2839	170
SC170SB-8-316	HydroScientific Sciclone™ SB 8 x 170 Multi Jumbo Filter Housing, ML, GB	6" FL	1 1/2"	1/2"	1/2"	-	1200	4542	272
SC170SB-12-316	HydroScientific Sciclone™ SB 12 x 170 Multi Jumbo Filter Housing, ML, GB	12" FL	1 1/2"	1/2"	1/2"	✓	1800	6816	432
SC170SB-16-316	HydroScientific Sciclone™ SB 16 x 170 Multi Jumbo Filter Housing, ML, GB	12" FL	2"	1/2"	1/2"	✓	2400	9088	576

SB = SWING BOLT, ML = LEGS, EP = ELECTROPOLISH, GB = GLASS BEAD

STAINLESS STEEL FILTER HOUSINGS

SC SERIES



FEATURES

- SCICLONIC™ Water Flow Design.
- Swing bolt closure for quick and secure filter change.
- Heavy duty 304 or 316 Stainless Steel for durability available.
- Legs and Electropolish are standard.
- Accepts Jumbo Style Cartridges.
- Radial Flow Entry.
- Stainless Steel Standpipes.

APPLICATIONS

- Residential, Commercial, Industrial and Municipal
- Cooling Tower Filtration
- Whole House Filtration
- Process Water
- Well Water
- Small Community Compliance
- Industrial Waste Water Treatment

ADDITIONAL FEATURES

Finish:	Electropolished and Bead Blasted Standard
Drains:	Clean and Dirty standard on all models
Gauge Ports:	Clean and Dirty standard on all models

MATERIALS OF CONSTRUCTION

Housing Shell:	304 or 316 Stainless Steel
Swing Bolt Lid Closure:	Zinc Plated Steel
Vent and Drain Plugs:	304 or 316 Stainless Steel
Heavy Duty Mounting Legs:	304 or 316 Stainless Steel
O-Ring / Gasket:	EPDM - FDA Grade (Viton, Silicone and EPR Options)

OPERATIONAL DATA

Max. Working Pressure:	150 psi at 300 °F (10.3 bar at 149 °C)
Max. Operating Temperature:	300 °F (149 °C)

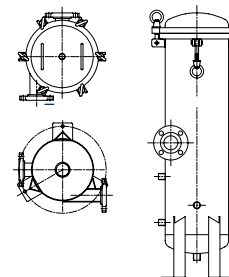
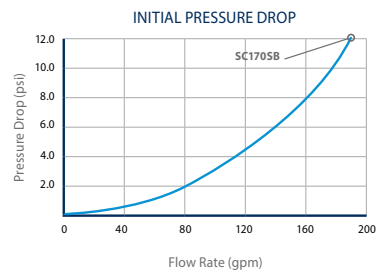
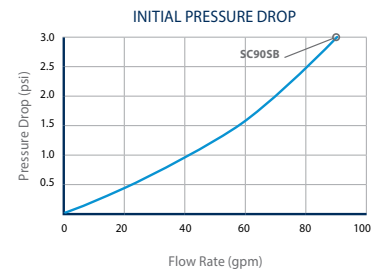
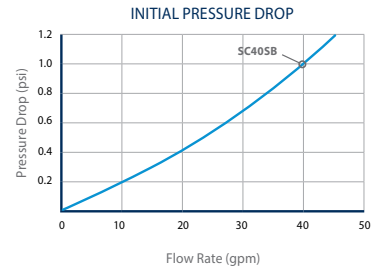
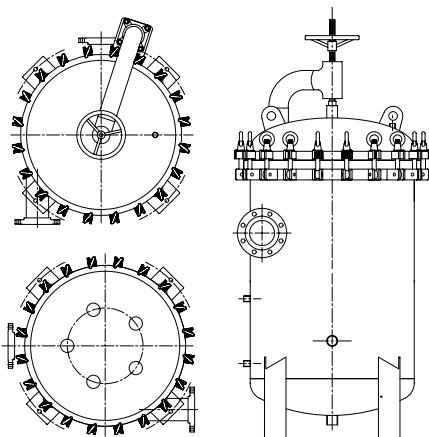



HIGH FLOW FILTER HOUSINGS

HF SERIES



HYDROSCIENTIFIC™ HF SERIES HIGH FLOW FILTER HOUSINGS are ideal for most industrial/commercial applications and are commonly used for pre-filtration for Reverse Osmosis (RO) systems, food service, car washes, and many other applications where high flow operation is required.

HYDROSCIENTIFIC™ HF SERIES HIGH FLOW FILTER HOUSINGS are made with a high grade 304 or 316 Stainless Steel, are available in numerous mounting configurations and accept various High Flow Filter Cartridges.



HF SERIES - 304 SS BAND CLAMP AND SWING BOLT HIGH FLOW HOUSING SPECIFICATIONS

Part Number	Description	Ports (In/Out)	Style	Max. Flow (gpm)	Max. Flow (lpm)	Max. Flow (m ³ /hr)
HFE-304	HydroScientific™ BC Economy 23" Single High Flow Filter Housing, MT, Buna N, EP	2" FNPT	V	100	568	23
HF2V-304-2F	HydroScientific™ SB 20" Single High Flow Filter Housing, ML, GP, EP	2" FL	V	100	568	23
HF4V-304-3F	HydroScientific™ SB 40" Single High Flow Filter Housing, ML, GP, EP	3" FL	V	250	946	57
HF4H-304-3F	HydroScientific™ SB 40" Single High Flow Filter Housing, ML, GP, EP	3" FL	H	250	946	57
HF6H-304-3F	HydroScientific™ SB 60" Single High Flow Filter Housing, ML, GP, EP	3" FL	H	300	1136	68
HF4H-304-6F3	HydroScientific™ SB 3 x 40" Multi High Flow Filter Housing, ML, GP, EP	6" FL	H	800	3028	182
HF6H-304-6F3	HydroScientific™ SB 3 x 60" Multi High Flow Filter Housing, ML, GP, EP	6" FL	H	900	3407	204
HF4H-304-6F4	HydroScientific™ SB 4 x 40" Multi High Flow Filter Housing, ML, GP, EP	6" FL	H	1100	4164	250
HF6H-304-6F4	HydroScientific™ SB 4 x 60" Multi High Flow Filter Housing, ML, GP, EP	6" FL	H	1200	4543	273
HF4H-304-8F7	HydroScientific™ SB 7 x 40" Multi High Flow Filter Housing, ML, GP, EP	8" FL	H	1800	6814	409
HF6H-304-8F7	HydroScientific™ SB 7 x 60" Multi High Flow Filter Housing, ML, GP, EP	8" FL	H	2500	9464	568
HF4H-304-12F12	HydroScientific™ SB 12 x 40" Multi High Flow Filter Housing, ML, GP, EP	12" FL	H	3000	11356	681
HF6H-304-12F12	HydroScientific™ SB 12 x 60" Multi High Flow Filter Housing, ML, GP, EP	12" FL	H	3600	13627	818

BC = BAND CLAMP, SB = SWING BOLT, ML = LEGS, MT = MOUNTING TABS, GP = GAUGE PORT, EP = ELECTROPOLISH, FL = FLANGE, V = VERTICAL, H = HORIZONTAL

HIGH FLOW FILTER HOUSINGS

HF SERIES



HF SERIES - 316 SS BAND CLAMP AND SWING BOLT HIGH FLOW HOUSING SPECIFICATIONS							
Part Number	Description	Ports (In/Out)	Style	Max. Flow (gpm)	Max. Flow (lpm)	Max. Flow (m ³ /hr)	
HFE-316	HydroScientific™ BC Economy 23" Single High Flow Filter Housing, MT, Buna N, GP, EP	2" FNPT	V	100	568	23	
HF2V-316-2F	HydroScientific™ SB 20" Single High Flow Filter Housing, ML, GP, EP	2" FL	V	100	568	23	
HF4V-316-3F	HydroScientific™ SB 40" Single High Flow Filter Housing, ML, GP, EP	3" FL	V	250	946	57	
HF4H-316-3F	HydroScientific™ SB 40" Single High Flow Filter Housing, ML, GP, EP	3" FL	H	250	946	57	
HF6H-316-3F	HydroScientific™ SB 60" Single High Flow Filter Housing, ML, GP, EP	3" FL	H	300	1136	68	
HF4H-316-6F3	HydroScientific™ SB 3 x 40" Multi High Flow Filter Housing, ML, GP, EP	6" FL	H	800	3028	182	
HF6H-316-6F3	HydroScientific™ SB 3 x 60" Multi High Flow Filter Housing, ML, GP, EP	6" FL	H	900	3407	204	
HF4H-316-6F4	HydroScientific™ SB 4 x 40" Multi High Flow Filter Housing, ML, GP, EP	6" FL	H	1100	4164	250	
HF6H-316-6F4	HydroScientific™ SB 4 x 60" Multi High Flow Filter Housing, ML, GP, EP	6" FL	H	1200	4543	273	
HF4H-316-8F7	HydroScientific™ SB 7 x 40" Multi High Flow Filter Housing, ML, GP, EP	8" FL	H	1800	6814	409	
HF6H-316-8F7	HydroScientific™ SB 7 x 60" Multi High Flow Filter Housing, ML, GP, EP	8" FL	H	2500	9464	568	
HF4H-316-12F12	HydroScientific™ SB 12 x 40" Multi High Flow Filter Housing, ML, GP, EP	12" FL	H	3000	11356	681	
HF6H-316-12F12	HydroScientific™ SB 12 x 60" Multi High Flow Filter Housing, ML, GP, EP	12" FL	H	3600	13627	818	

BC = BAND CLAMP, SB = SWING BOLT, ML = LEGS, MT = MOUNTING TABS, GP = GAUGE PORT, EP = ELECTROPOLISH, FL = FLANGE, V = VERTICAL, H = HORIZONTAL

APPLICATIONS

- Residential, Commercial and Industrial
- Cooling Tower Filtration
- Whole House Filtration
- Process Water
- Well Water
- Industrial Waste Water Treatment

FEATURES

- Electropolished 304 or 316 Stainless Steel.
- Band Clamp or Swing Bolt Design for Fast/Easy Operation.
- Accepts High Flow Cartridges.
- Multiple Size options to best meet your application.
- Horizontal and Vertical options.

Copyright © 2019 HydroScientific., All Rights Reserved.

MATERIALS OF CONSTRUCTION

Housing: 304 or 316 Stainless Steel
 Closure: Stainless Steel
 O-Ring: EPDM (FDA Grade)

OPERATIONAL DATA

Max. Working Pressure: 150 psi at 250 °F (10.3 bar at 121 °C)
 Max. Operating Temperature: 250 °F (121 °C)

PORT DIMENSIONS

Vents: 1/4" and 1/2" NPT
 Drain: 1/2" and 1" NPT
 Inlet: 2" NPT, 3" through 12" Flange
 Outlet: 2" NPT, 3" through 12" Flange

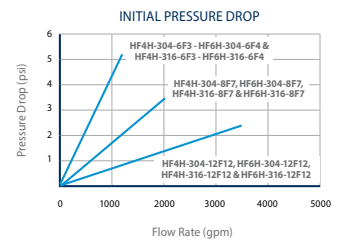
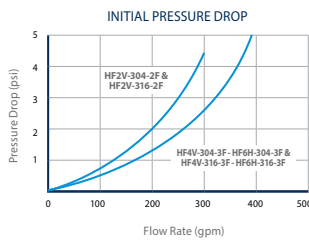
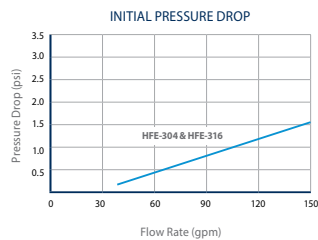



BAND CLAMP JUMBO FILTER HOUSINGS

HBCJ SERIES



HYDROSCIENTIFIC™ BAND CLAMP JUMBO FILTER HOUSINGS provide exceptional performance and deliver durability, quality and price.

HYDROSCIENTIFIC™ BAND CLAMP JUMBO FILTER HOUSINGS come with Stainless Steel standpipes as a standard feature and through their JUMBO radial flow water entry, water enters the housing and forces water more effectively through the cartridges pleated filter media.



HBCJ SERIES - 304SS BAND CLAMP JUMBO FILTER HOUSING SPECIFICATIONS

Part Number	Description	Ports (In/Out)	Drains	Vents	Max. Flow Rate (gpm)
HBCJ40	HydroScientific™ Band Clamp 40 Jumbo Filter Housing, ML, EP	2" FNPT	1" FNPT	1/4" FNPT	50
HBCJ90	HydroScientific™ Band Clamp 90 Jumbo Filter Housing, ML, EP	2" FNPT	1" FNPT	1/4" FNPT	100
HBCJ170	HydroScientific™ Band Clamp 170 Jumbo Filter Housing, ML, EP	2" FNPT	1" FNPT	1/4" FNPT	150

HBCJ SERIES - 316SS BAND CLAMP JUMBO FILTER HOUSING SPECIFICATIONS

Part Number	Description	Ports (In/Out)	Drains	Vents	Max. Flow Rate (gpm)
HBCJ40-316	HydroScientific™ Band Clamp 40 Jumbo Filter Housing, ML, EP	2" FNPT	1" FNPT	1/4" FNPT	50
HBCJ90-316	HydroScientific™ Band Clamp 90 Jumbo Filter Housing, ML, EP	2" FNPT	1" FNPT	1/4" FNPT	100
HBCJ170-316	HydroScientific™ Band Clamp 170 Jumbo Filter Housing, ML, EP	2" FNPT	1" FNPT	1/4" FNPT	150

ML = LEGS, EP = ELECTROPOLISH

BAND CLAMP JUMBO FILTER HOUSINGS

HBCJ SERIES



APPLICATIONS

- Residential, Commercial and Industrial
- Cooling Tower Filtration
- Whole House Filtration
- Process Water
- Well Water
- Small Community Compliance
- Industrial Waste Water Treatment

FEATURES

- 304 or 316 Stainless Steel.
- Electropolished standard on all models.
- Band Clamp Design for Fast / Easy / Safe Operation.
- Stainless Steel Standpipe.
- Accepts Jumbo Style Cartridges.
- Multiple Size options to best meet your application.

ADDITIONAL FEATURES

Finish: Electropolished and Bead Blasted Standard
 Drains: Clean and Dirty standard on all models

MATERIALS OF CONSTRUCTION

Housing Shell: 304 or 316 Stainless Steel
 Band Clamp Lid Closure: 304 or 316 Stainless Steel
 Vent and Drain Plugs: 304 or 316 Stainless Steel
 Heavy Duty Mounting Legs: 304 or 316 Stainless Steel
 O-Ring/Gasket: EPDM - FDA Grade
 (Viton, Silicone and EPR Options)

OPERATIONAL DATA

Max. Working Pressure: 150 psi at 250°F (10.3 bar at 121°C)
 Max. Operating Temperature: 250 °F (121 °C)

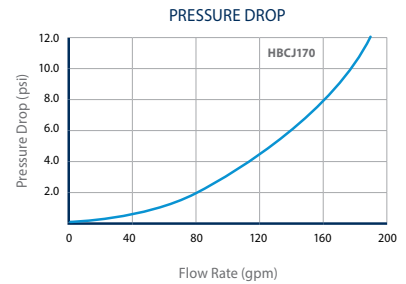
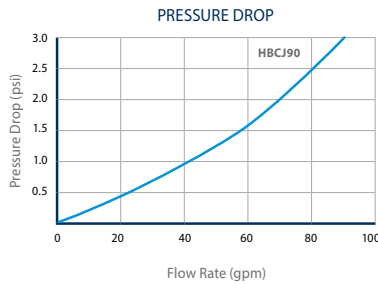
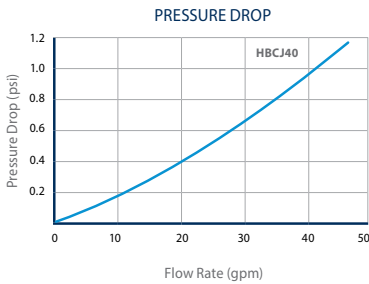
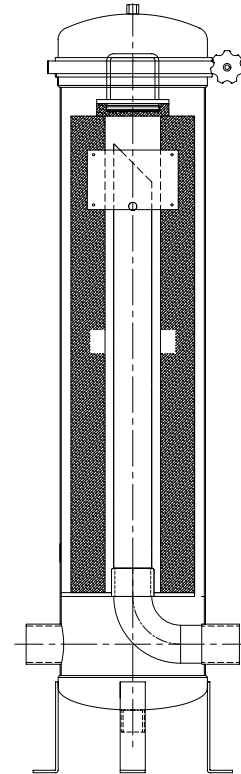
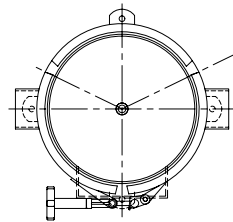



SWING BOLT JUMBO FILTER HOUSINGS

HSBJ SERIES



HYDROSCIENTIFIC™ SWING BOLT JUMBO FILTER HOUSINGS provide an exceptional performance that delivers durability, quality and price.

HYDROSCIENTIFIC™ SWING BOLT JUMBO FILTER HOUSINGS come with Stainless Steel standpipes as a standard feature and through their JUMBO radial flow water entry, water enters the housing and forces water more effectively through the cartridges pleated filter media.



HSBJ SERIES - 304SS SWING BOLT JUMBO FILTER HOUSING SPECIFICATIONS

Part Number	Description	Ports (In/Out)	Drains (FNPT)	Vents (FNPT)	Gauge Port (FNPT)	Swing Arm	Max. Flow (gpm)	Max. Flow (lpm)	Max. Flow (m ³ /hr)
HSBJ40	HydroScientific™ SB 40 Jumbo Filter Housing, ML, EP	2" FNPT	1"	1/4"	-	-	50	189	12
HSBJ90	HydroScientific™ SB 90 Jumbo Filter Housing, ML, EP	2" FNPT	1"	1/4"	-	-	100	378	24
HSBJ170	HydroScientific™ SB 170 Jumbo Filter Housing, ML, EP	2" FNPT	1"	1/4"	-	-	150	568	36
HSBJ170SB-3	HydroScientific™ SB 3 x 170 Jumbo Filter Housing, ML, EP	4" FL	1 1/2"	1/2"	1/2"	-	450	1703	102
HSBJ170SB-4	HydroScientific™ SB 4 x 170 Jumbo Filter Housing, ML, EP	6" FL	1 1/2"	1/2"	1/2"	-	600	2272	144
HSBJ170SB-5	HydroScientific™ SB 5 x 170 Jumbo Filter Housing, ML, EP	6" FL	1 1/2"	1/2"	1/2"	-	750	2839	170
HSBJ170SB-8	HydroScientific™ SB 8 x 170 Jumbo Filter Housing, ML, EP	6" FL	1 1/2"	1/2"	1/2"	-	1200	4542	272
HSBJ170SB-12	HydroScientific™ SB 12 x 170 Jumbo Filter Housing, ML, GB	12" FL	1 1/2"	1/2"	1/2"	✓	1800	6816	432
HSBJ170SB-16	HydroScientific™ SB 16 x 170 Jumbo Filter Housing, ML, GB	12" FL	2"	1/2"	1/2"	✓	2400	9088	576

HSBJ SERIES - 316SS SWING BOLT JUMBO FILTER HOUSING SPECIFICATIONS

Part Number	Description	Ports (In/Out)	Drains (FNPT)	Vents (FNPT)	Gauge Port (FNPT)	Swing Arm	Max. Flow (gpm)	Max. Flow (lpm)	Max. Flow (m ³ /hr)
HSBJ40-316	HydroScientific™ SB 40 Jumbo Filter Housing, ML, EP	2" FNPT	1"	1/4"	-	-	50	189	12
HSBJ90-316	HydroScientific™ SB 90 Jumbo Filter Housing, ML, EP	2" FNPT	1"	1/4"	-	-	100	378	24
HSBJ170-316	HydroScientific™ SB 170 Jumbo Filter Housing, ML, EP	2" FNPT	1"	1/4"	-	-	150	568	36
HSBJ170SB-3-316	HydroScientific™ SB 3 x 170 Jumbo Filter Housing, ML, EP	4" FL	1 1/2"	1/2"	1/2"	-	450	1703	102
HSBJ170SB-4-316	HydroScientific™ SB 4 x 170 Jumbo Filter Housing, ML, EP	6" FL	1 1/2"	1/2"	1/2"	-	600	2272	144
HSBJ170SB-5-316	HydroScientific™ SB 5 x 170 Jumbo Filter Housing, ML, EP	6" FL	1 1/2"	1/2"	1/2"	-	750	2839	170
HSBJ170SB-8-316	HydroScientific™ SB 8 x 170 Jumbo Filter Housing, ML, EP	6" FL	1 1/2"	1/2"	1/2"	-	1200	4542	272
HSBJ170SB12-316	HydroScientific™ SB 12 x 170 Jumbo Filter Housing, ML, GB	12" FL	1 1/2"	1/2"	1/2"	✓	1800	6816	432
HSBJ170SB16-316	HydroScientific™ SB 16 x 170 Jumbo Filter Housing, ML, GB	12" FL	2"	1/2"	1/2"	✓	2400	9088	576

SB = SWING BOLT, ML = LEGS, EP = ELECTROPOLISH, GB = GLASS BEAD, FL = FLANGE

SWING BOLT JUMBO FILTER HOUSINGS

HSBJ SERIES



APPLICATIONS

- Residential, Commercial, Industrial and Municipal
- Cooling Tower Filtration
- Whole House Filtration
- Process Water
- Well Water
- Small Community Compliance
- Industrial Waste Water Treatment

FEATURES

- 304 or 316 Stainless Steel.
- Electropolished standard on all models.
- Swing Bolt Design for Fast/Easy Operation.
- Stainless Steel Standpipe.
- Accepts Jumbo Style Cartridges.
- Multiple Size options to best meet your application.

ADDITIONAL FEATURES

Finish: Electropolished and Bead Blasted Standard
 Drains: Clean and Dirty standard on all models
 Gauge Ports: Clean and Dirty standard on all models

MATERIALS OF CONSTRUCTION

Housing Shell: 304 or 316 Stainless Steel
 Lid Closure: Zinc Plated Steel
 Vent and Drain Plugs: 304 or 316 Stainless Steel
 Heavy Duty Mounting Legs: 304 or 316 Stainless Steel
 O-Ring/Gasket: EPDM - FDA Grade
 (Viton, Silicone and EPR Options)

OPERATIONAL DATA

Max. Working Pressure: 150 psi at 300°F (10.3 bar at 149°C)
 Max. Operating Temperature: 300°F (149°C)

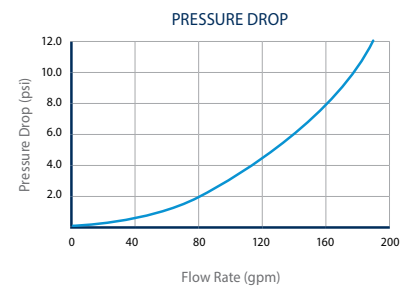
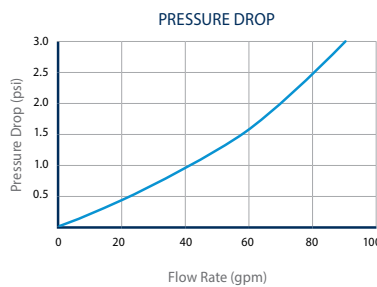
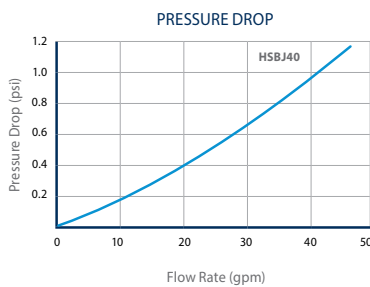
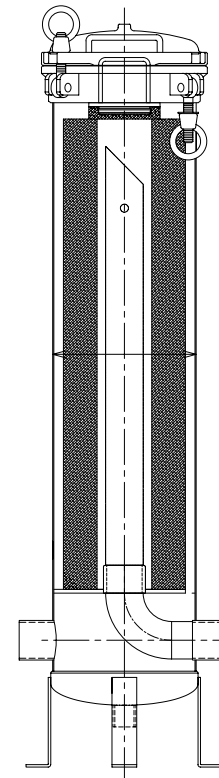
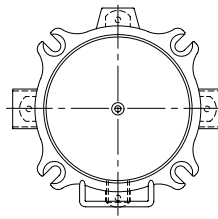



BAND CLAMP & SWING BOLT BAG HOUSINGS

BF/MBF SERIES



HYDROSCIENTIFIC™ BF/MBF SERIES BAG FILTER HOUSINGS are ideal for most commercial / industrial applications. Commonly used for pre-filtration for Reverse Osmosis (RO) systems, food service, car washes, agriculture and many other uses.

HYDROSCIENTIFIC™ BF/MBF SERIES BAG FILTER HOUSINGS are made with high grade 304 or 316 Stainless Steel and easily accept most standard filter bags. With a wide range of models, these housings can easily meet most application requirements.



BF SERIES - 304SS AND 316SS BAND CLAMP SINGLE BAG HOUSING (#1, #2, #3 AND #4) SPECIFICATIONS									
Part Number	Description	Ports (In/Out)	Drains (FNPT)	Vents (FNPT)	Gauge Ports	Max. Flow (gpm)	Max. Flow (lpm)	Max. Flow (m ³ /hr)	
BF1-304-2NBC	HydroScientific™ BC Single Bag Housing, 1 x #1, 304SS, AL, EP	2" FNPT	-	1/4" FNPT	1/4" FNPT	90	340	20	
BF2-304-2NBC	HydroScientific™ BC Single Bag Housing, 1 x #2, 304SS, AL, EP	2" FNPT	-	1/4" FNPT	1/4" FNPT	180	681	41	
BF3-304-1NBC	HydroScientific™ BC Single Bag Housing, 1 x #3, 304SS, AL, EP	1" FNPT	-	1/4" FNPT	1/4" FNPT	20	76	4.5	
BF4-304-1NBC	HydroScientific™ BC Single Bag Housing, 1 x #4, 304SS, AL, EP	1" FNPT	-	1/4" FNPT	1/4" FNPT	45	170	10	
BF1-316-2NBC	HydroScientific™ BC Single Bag Housing, 1 x #1, 316SS, AL, EP	2" FNPT	-	1/4" FNPT	1/4" FNPT	90	340	20	
BF2-316-2NBC	HydroScientific™ BC Single Bag Housing, 1 x #2, 316SS, AL, EP	2" FNPT	-	1/4" FNPT	1/4" FNPT	180	681	41	
BF3-316-1NBC	HydroScientific™ BC Single Bag Housing, 1 x #3, 316SS, AL, EP	1" FNPT	-	1/4" FNPT	1/4" FNPT	20	76	4.5	
BF4-316-1NBC	HydroScientific™ BC Single Bag Housing, 1 x #4, 316SS, AL, EP	1" FNPT	-	1/4" FNPT	1/4" FNPT	45	170	10	

BF SERIES - 304SS AND 316SS SWING BOLT SINGLE BAG HOUSING (#1 AND #2) SPECIFICATIONS									
Part Number	Description	Ports (In/Out)	Drains (FNPT)	Vents (FNPT)	Gauge Ports	Max. Flow (gpm)	Max. Flow (lpm)	Max. Flow (m ³ /hr)	
BF1-304-2N	HydroScientific™ SB Single Bag Housing, 1 x #1, 304SS, AL, EP	2" FNPT	-	1/4" FNPT	1/4" FNPT	90	340	20	
BF2-304-2N	HydroScientific™ SB Single Bag Housing, 1 x #2, 304SS, AL, EP	2" FNPT	-	1/4" FNPT	1/4" FNPT	180	681	41	
BF1-316-2N	HydroScientific™ SB Single Bag Housing, 1 x #1, 316SS, AL, EP	2" FNPT	-	1/4" FNPT	1/4" FNPT	90	340	20	
BF2-316-2N	HydroScientific™ SB Single Bag Housing, 1 x #2, 316SS, AL, EP	2" FNPT	-	1/4" FNPT	1/4" FNPT	180	681	41	

BF SERIES - CARBON STEEL SWING BOLT SINGLE BAG HOUSING (#1 AND #2) SPECIFICATIONS									
Part Number	Description	Ports (In/Out)	Drains (FNPT)	Vents (FNPT)	Gauge Ports	Max. Flow (gpm)	Max. Flow (lpm)	Max. Flow (m ³ /hr)	
BF1-C-2N	HydroScientific™ SB Single Bag Housing, 1 x #1, CS, AL, EP	2" FNPT	-	1/4" FNPT	1/4" FNPT	90	340	20	
BF2-C-2N	HydroScientific™ SB Single Bag Housing, 1 x #2, CS, AL, EP	2" FNPT	-	1/4" FNPT	1/4" FNPT	180	681	41	

BC = BAND CLAMP, SB = SWING BOLT, CS = CARBON STEEL, AL = ADJUSTABLE LEGS, EP = ELECTROPOLISH

BAND CLAMP & SWING BOLT BAG HOUSINGS

BF/MBF SERIES



MBF SERIES - 304SS SWING BOLT MULTI BAG HOUSING SPECIFICATIONS										
Part Number	Description	Ports (In/Out)	Drains (FNPT)	Vents (FNPT)	Gauge Ports (FNPT)	Swing Arm	Max. Flow (gpm)	Max. Flow (lpm)	Max. Flow (m ³ /hr)	
MBF2-304-3F	HydroScientific™ SB Multi Bag Housing, 2 x #2, ML, EP	3" FL	2"	1/2"	1/2"	✓	396	1499	90	
MBF3-304-4F	HydroScientific™ SB Multi Bag Housing, 3 x #2, ML, EP	4" FL	2"	1/2"	1/2"	✓	594	2248	135	
MBF4-304-4F	HydroScientific™ SB Multi Bag Housing, 4 x #2, ML, EP	4" FL	2"	1/2"	1/2"	✓	793	3001	180	
MBF5-304-6F	HydroScientific™ SB Multi Bag Housing, 5 x #2, ML, EP	6" FL	2"	1/2"	1/2"	✓	991	3751	225	
MBF6-304-6F	HydroScientific™ SB Multi Bag Housing, 6 x #2, ML, EP	6" FL	2"	1/2"	1/2"	✓	1189	4501	270	
MBF8-304-8F	HydroScientific™ SB Multi Bag Housing, 8 x #2, ML, EP	8" FL	2"	1/2"	1/2"	✓	1585	6000	360	
MBF12-304-8F	HydroScientific™ SB Multi Bag Housing, 12 x #2, ML, EP	8" FL	2"	1/2"	1/2"	✓	2378	9002	540	
MBF12-304-10F	HydroScientific™ SB Multi Bag Housing, 12 x #2, ML, EP	10" FL	2"	1/2"	1/2"	✓	2378	9002	540	

MBF SERIES - 316SS SWING BOLT MULTI BAG HOUSING SPECIFICATIONS										
Part Number	Description	Ports (In/Out)	Drains (FNPT)	Vents (FNPT)	Gauge Ports (FNPT)	Swing Arm	Max. Flow (gpm)	Max. Flow (lpm)	Max. Flow (m ³ /hr)	
MBF2-316-3F	HydroScientific™ SB Multi Bag Housing, 2 x #2, ML, EP	3" FL	2"	1/2"	1/2"	✓	396	1499	90	
MBF3-316-4F	HydroScientific™ SB Multi Bag Housing, 3 x #2, ML, EP	4" FL	2"	1/2"	1/2"	✓	594	2248	135	
MBF4-316-4F	HydroScientific™ SB Multi Bag Housing, 4 x #2, ML, EP	4" FL	2"	1/2"	1/2"	✓	793	3001	180	
MBF5-316-6F	HydroScientific™ SB Multi Bag Housing, 5 x #2, ML, EP	6" FL	2"	1/2"	1/2"	✓	991	3751	225	
MBF6-316-6F	HydroScientific™ SB Multi Bag Housing, 6 x #2, ML, EP	6" FL	2"	1/2"	1/2"	✓	1189	4501	270	
MBF8-316-8F	HydroScientific™ SB Multi Bag Housing, 8 x #2, ML, EP	8" FL	2"	1/2"	1/2"	✓	1585	6000	360	
MBF12-316-8F	HydroScientific™ SB Multi Bag Housing, 12 x #2, ML, EP	8" FL	2"	1/2"	1/2"	✓	2378	9002	540	
MBF12-316-10F	HydroScientific™ SB Multi Bag Housing, 12 x #2, ML, EP	10" FL	2"	1/2"	1/2"	✓	2378	9002	540	

SB = SWING BOLT, ML = LEGS, EP = ELECTROPOLISH, FL = FLANGE

FEATURES

- Band Clamp or Swing Bolt Design.
- 304 or 316 Stainless Steel.
- Electropolish standard on all models.
- Positive O-Ring Seal.
- Single and Multi-Bag Filter Housing Options.
- 150 psi Pressure Rating.
- Accepts #1 (7" x 16-1/2") or #2 (7" x 32") Filter Bags.

APPLICATIONS

- Liquid Process
- Food and Beverage
- Chemicals
- Oil / Gas Industry
- Coolants
- Inks / Coatings / Paints
- Wastewater

MATERIALS OF CONSTRUCTION

Housing Shell:	304 or 316 Stainless Steel
Band Clamp Lid Closure:	304 or 316 Stainless Steel
Swing Bolt Lid Closure:	Zinc Plated Steel
Vent and Drain Plugs:	304 or 316 Stainless Steel
Heavy Duty Mounting Legs:	304 or 316 Stainless Steel
O-Ring / Gasket:	EPDM - FDA Grade (Viton, Silicone and EPR Options)

ADDITIONAL FEATURES

Finish:	Electropolished & Bead Blasted Standard
Drains:	Clean and Dirty standard on all models
Gauge Ports:	Clean and Dirty standard on all models

OPERATIONAL DATA

Max. Working Pressure:	150 psi at 250 °F (10.3 bar at 121 °C) - Band Clamp 150 psi at 300 °F (10.3 bar at 149 °C) - Swing Bolt
Max. Operating Temperature:	250 °F (121 °C) - Band Clamp 300 °F (149 °C) - Swing Bolt

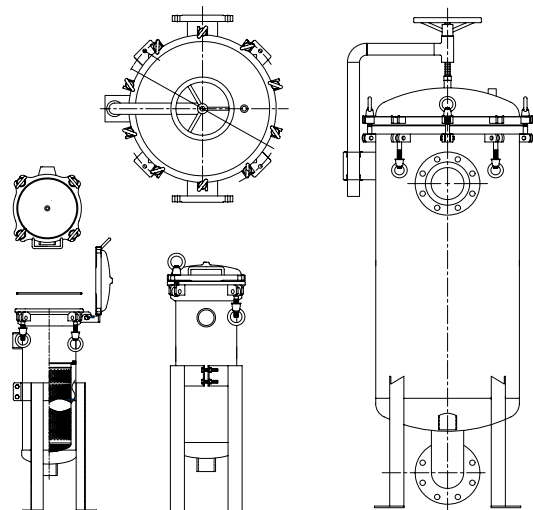



BAND CLAMP MULTI ROUND FILTER HOUSINGS

MRH / MRHS SERIES



HYDROSCIENTIFIC™ MRH / MRHS SERIES - BAND CLAMP MULTI ROUND FILTER HOUSINGS

are ideal for most industrial/commercial applications with our welded leg design as a standard, (not "optional") feature, we eliminate the added expense to your application. MRH/MRHS Band Clamp Housings are commonly used for pre-filtration for Reverse Osmosis (RO) systems, food service, car washes, agriculture and many other uses.

HYDROSCIENTIFIC™ MRH / MRHS SERIES - BAND CLAMP MULTI ROUND FILTER HOUSINGS

are made with a high grade 304 or 316 Stainless Steel as standard and accept a wide range of filter cartridges.



HYDROSCIENTIFIC™ MRH SERIES - 304SS BAND CLAMP MULTI ROUND FILTER HOUSING SPECIFICATIONS

Part Number	Description	Ports (In/Out)	Drains (FNPT/ MNPT)	Gauge Port	Max. Flow (gpm)	Max. Flow (lpm)	Max. Flow (m ³ /hr)	No. of Cartridges
MRH-410-2BC	HydroScientific™ BC 4 x 10" Multi Filter Housing, ML, EP	2" FNPT	3/4" MNPT	1/4" FNPT	28	106	6	4
MRH-420-2BC	HydroScientific™ BC 4 x 20" Multi Filter Housing, ML, EP	2" FNPT	3/4" MNPT	1/4" FNPT	56	212	13	4
MRH-430-2BC	HydroScientific™ BC 4 x 30" Multi Filter Housing, ML, EP	2" FNPT	3/4" MNPT	1/4" FNPT	84	318	19	4
MRH-440-2BC	HydroScientific™ BC 4 x 40" Multi Filter Housing, ML, EP	2" FNPT	3/4" MNPT	1/4" FNPT	112	424	25	4
MRH-510-2BC	HydroScientific™ BC 5 x 10" Multi Filter Housing, ML, EP	2" FNPT	3/4" MNPT	1/4" FNPT	35	132	8	5
MRH-520-2BC	HydroScientific™ BC 5 x 20" Multi Filter Housing, ML, EP	2" FNPT	3/4" MNPT	1/4" FNPT	70	265	16	5
MRH-530-2BC	HydroScientific™ BC 5 x 30" Multi Filter Housing, ML, EP	2" FNPT	3/4" MNPT	1/4" FNPT	105	397	24	5
MRH-540-2BC	HydroScientific™ BC 5 x 40" Multi Filter Housing, ML, EP	2" FNPT	3/4" MNPT	1/4" FNPT	140	530	32	5
MRH-710-2BC	HydroScientific™ BC 7 x 10" Multi Filter Housing, ML, EP	2" FNPT	3/4" MNPT	1/4" FNPT	49	185	11	7
MRH-720-2BC	HydroScientific™ BC 7 x 20" Multi Filter Housing, ML, EP	2" FNPT	3/4" MNPT	1/4" FNPT	98	371	22	7
MRH-730-2BC	HydroScientific™ BC 7 x 30" Multi Filter Housing, ML, EP	2" FNPT	3/4" MNPT	1/4" FNPT	147	556	33	7
MRH-740-2BC	HydroScientific™ BC 7 x 40" Multi Filter Housing, ML, EP	2" FNPT	3/4" MNPT	1/4" FNPT	196	742	45	7

BC = BAND CLAMP, ML = LEGS, EP = ELECTROPOLISH

BAND CLAMP MULTI ROUND FILTER HOUSINGS

MRH / MRHS SERIES



HYDROSCIENTIFIC™ MRHS SERIES - 316SS BAND CLAMP MULTI ROUND FILTER HOUSING SPECIFICATIONS								
Part Number	Description	Ports (In/Out)	Drains (FNPT/ MNPT)	Gauge Port	Max. Flow (gpm)	Max. Flow (lpm)	Max. Flow (m ³ /hr)	No. of Cartridges
MRHS-410-2BC	HydroScientific™ BC 4 x 10" Multi Filter Housing, ML, EP	2" FNPT	3/4" MNPT	1/4" FNPT	28	106	6	4
MRHS-420-2BC	HydroScientific™ BC 4 x 20" Multi Filter Housing, ML, EP	2" FNPT	3/4" MNPT	1/4" FNPT	56	212	13	4
MRHS-430-2BC	HydroScientific™ BC 4 x 30" Multi Filter Housing, ML, EP	2" FNPT	3/4" MNPT	1/4" FNPT	84	318	19	4
MRHS-440-2BC	HydroScientific™ BC 4 x 40" Multi Filter Housing, ML, EP	2" FNPT	3/4" MNPT	1/4" FNPT	112	424	25	4
MRHS-510-2BC	HydroScientific™ BC 5 x 10" Multi Filter Housing, ML, EP	2" FNPT	3/4" MNPT	1/4" FNPT	35	132	8	5
MRHS-520-2BC	HydroScientific™ BC 5 x 20" Multi Filter Housing, ML, EP	2" FNPT	3/4" MNPT	1/4" FNPT	70	265	16	5
MRHS-530-2BC	HydroScientific™ BC 5 x 30" Multi Filter Housing, ML, EP	2" FNPT	3/4" MNPT	1/4" FNPT	105	397	24	5
MRHS-540-2BC	HydroScientific™ BC 5 x 40" Multi Filter Housing, ML, EP	2" FNPT	3/4" MNPT	1/4" FNPT	140	530	32	5
MRHS-710-2BC	HydroScientific™ BC 7 x 10" Multi Filter Housing, ML, EP	2" FNPT	3/4" MNPT	1/4" FNPT	49	185	11	7
MRHS-720-2BC	HydroScientific™ BC 7 x 20" Multi Filter Housing, ML, EP	2" FNPT	3/4" MNPT	1/4" FNPT	98	371	22	7
MRHS-730-2BC	HydroScientific™ BC 7 x 30" Multi Filter Housing, ML, EP	2" FNPT	3/4" MNPT	1/4" FNPT	147	556	33	7
MRHS-740-2BC	HydroScientific™ BC 7 x 40" Multi Filter Housing, ML, EP	2" FNPT	3/4" MNPT	1/4" FNPT	196	742	45	7

BC = BAND CLAMP, ML = LEGS, EP = ELECTROPOLISH

FEATURES

- Electropolished 304 or 316 Stainless Steel (coated options available).
- Band Clamp Design for Fast/Easy/Safe Operation.
- Accepts DOE, 222/Flat or 222/Fin Cartridges.
- Two-gauge ports – inlet and outlet .
- Two drains provided – inlet and outlet.
- Adjustable top plates to accept various length filter cartridges.

APPLICATIONS

- Residential, Commercial, Industrial, and Municipal
- Reverse Osmosis Pre-filtration
- Ground Water Remediation
- Industrial Process (High Purity) Applications
- Cooling Tower Filtration
- Process Water
- Industrial Waste Water Treatment

Copyright © 2019 HydroScientific., All Rights Reserved.

ADDITIONAL FEATURES

Finish: Electropolished and Bead Blasted Standard
 Drains: Clean and Dirty standard on all models
 Gauge Ports: Clean and Dirty standard on all models
 Cartridge Types: MRH DOE Style Cartridges (2-3/4" max. diameter)
 All MRH Filter Housings will accept DOE, 222/Flat or 222/Fin Cartridges Standard

MATERIALS OF CONSTRUCTION

Housing Shell: 304 or 316 Stainless Steel
 Lid Closure: 304 or 316 Stainless Steel
 Vent and Drain Plugs: 304 or 316 Stainless Steel
 Heavy Duty Mounting Legs: 304 or 316 Stainless Steel
 O-Ring / Gasket: EPDM - FDA Grade
 (Viton, Silicone and EPR Options)

OPERATIONAL DATA

Max. Working Pressure: 150 psi at 250 °F (10.3 bar at 121 °C)
 Max. Operating Temperature: 250 °F (121 °C)



SWING BOLT MULTI ROUND FILTER HOUSINGS

MRH / MRHS SERIES



HYDROSCIENTIFIC™ MRH / MRHS SERIES - SWING BOLT MULTI ROUND FILTER HOUSINGS

are ideal for most industrial/commercial applications with our welded leg design as a standard, (not "optional") feature, we eliminate the added expense to your application. MRH/MRHS Swing Bolt Multi Round Housings are commonly used for pre-filtration for Reverse Osmosis (RO) systems, food service, car washes, agriculture and many other uses.

HYDROSCIENTIFIC™ MRH / MRHS SERIES - SWING BOLT MULTI ROUND FILTER HOUSINGS

are made with a high grade 304 or 316 Stainless Steel as standard and accept a wide range of filter cartridges.



HYDROSCIENTIFIC™ MRH SERIES - 304SS SWING BOLT MULTI ROUND FILTER HOUSING SPECIFICATIONS									
Part Number	Description	Ports (In/Out)	Drains (FNPT/MNPT)	Gauge Port	Max. Flow (gpm)	Max. Flow (lpm)	Max. Flow (m ³ /hr)	No. of Cartridges	
MRH-410-2	HydroScientific™ SB 4 x 10" Multi Filter Housing, ML, EP	2" FNPT	3/4" MNPT	1/4" FNPT	28	106	6	4	
MRH-420-2	HydroScientific™ SB 4 x 20" Multi Filter Housing, ML, EP	2" FNPT	3/4" MNPT	1/4" FNPT	56	212	13	4	
MRH-430-2	HydroScientific™ SB 4 x 30" Multi Filter Housing, ML, EP	2" FNPT	3/4" MNPT	1/4" FNPT	84	318	19	4	
MRH-440-2	HydroScientific™ SB 4 x 40" Multi Filter Housing, ML, EP	2" FNPT	3/4" MNPT	1/4" FNPT	112	424	25	4	
MRH-510-2	HydroScientific™ SB 5 x 10" Multi Filter Housing, ML, EP	2" FNPT	3/4" MNPT	1/4" FNPT	35	132	8	5	
MRH-520-2	HydroScientific™ SB 5 x 20" Multi Filter Housing, ML, EP	2" FNPT	3/4" MNPT	1/4" FNPT	70	265	16	5	
MRH-530-2	HydroScientific™ SB 5 x 30" Multi Filter Housing, ML, EP	2" FNPT	3/4" MNPT	1/4" FNPT	105	397	24	5	
MRH-540-2	HydroScientific™ SB 5 x 40" Multi Filter Housing, ML, EP	2" FNPT	3/4" MNPT	1/4" FNPT	140	530	32	5	
MRH-710-2	HydroScientific™ SB 7 x 10" Multi Filter Housing, ML, EP	2" FNPT	3/4" MNPT	1/4" FNPT	49	185	11	7	
MRH-720-2	HydroScientific™ SB 7 x 20" Multi Filter Housing, ML, EP	2" FNPT	3/4" MNPT	1/4" FNPT	98	371	22	7	
MRH-730-2	HydroScientific™ SB 7 x 30" Multi Filter Housing, ML, EP	2" FNPT	3/4" MNPT	1/4" FNPT	147	556	33	7	
MRH-740-2	HydroScientific™ SB 7 x 40" Multi Filter Housing, ML, EP	2" FNPT	3/4" MNPT	1/4" FNPT	196	742	45	7	
MRH-1230-3FL	HydroScientific™ SB 12 x 30" Multi Filter Housing, ML, EP	3" FL	1" FNPT	1/4" FNPT	252	954	57	12	
MRH-1240-3FL	HydroScientific™ SB 12 x 40" Multi Filter Housing, ML, EP	3" FL	1" FNPT	1/4" FNPT	336	1272	76	12	
MRH-2230-4FL	HydroScientific™ SB 22 x 30" Multi Filter Housing, ML, EP	4" FL	1" FNPT	1/2" FNPT	462	1749	105	22	
MRH-2240-4FL	HydroScientific™ SB 22 x 40" Multi Filter Housing, ML, EP	4" FL	1" FNPT	1/2" FNPT	616	2332	140	22	
MRH-3630-6FL	HydroScientific™ SB 36 x 30" Multi Filter Housing, ML, GB	6" FL	1" FNPT	1/2" FNPT	756	2862	172	36	
MRH-3640-6FL	HydroScientific™ SB 36 x 40" Multi Filter Housing, ML, GB	6" FL	1" FNPT	1/2" FNPT	1008	3816	229	36	
MRH-5230-6FL	HydroScientific™ SB 52 x 30" Multi Filter Housing, ML, GB	6" FL	1" FNPT	1/2" FNPT	1092	4134	248	52	
MRH-5240-6FL	HydroScientific™ SB 52 x 40" Multi Filter Housing, ML, GB	6" FL	1" FNPT	1/2" FNPT	1456	5512	331	52	
MRH-8530-8FL	HydroScientific™ SB 85 x 30" Multi Filter Housing, ML, GB	8" FL	1" FNPT	1/2" FNPT	1785	6757	405	85	
MRH-8540-8FL	HydroScientific™ SB 85 x 40" Multi Filter Housing, ML, GB	8" FL	1" FNPT	1/2" FNPT	2380	9009	649	85	

SB = SWING BOLT, ML = LEGS, EP = ELECTROPOLISH, GB = GLASS BEAD

SWING BOLT MULTI ROUND FILTER HOUSINGS

MRH / MRHS SERIES



HYDROSCIENTIFIC™ MRHS SERIES - 316SS SWING BOLT MULTI ROUND FILTER HOUSING SPECIFICATIONS								
Part Number	Description	Ports (In/Out)	Drains (FNPT/ MNPT)	Gauge Port	Max. Flow (gpm)	Max. Flow (lpm)	Max. Flow (m ³ /hr)	No. of Cartridges
MRHS-410-2	HydroScientific™ SB 4 x 10" Multi Filter Housing, ML, EP	2" FNPT	3/4" MNPT	1/4" FNPT	28	106	6	4
MRHS-420-2	HydroScientific™ SB 4 x 20" Multi Filter Housing, ML, EP	2" FNPT	3/4" MNPT	1/4" FNPT	56	212	13	4
MRHS-430-2	HydroScientific™ SB 4 x 30" Multi Filter Housing, ML, EP	2" FNPT	3/4" MNPT	1/4" FNPT	84	318	19	4
MRHS-440-2	HydroScientific™ SB 4 x 40" Multi Filter Housing, ML, EP	2" FNPT	3/4" MNPT	1/4" FNPT	112	424	25	4
MRHS-510-2	HydroScientific™ SB 5 x 10" Multi Filter Housing, ML, EP	2" FNPT	3/4" MNPT	1/4" FNPT	35	132	8	5
MRHS-520-2	HydroScientific™ SB 5 x 20" Multi Filter Housing, ML, EP	2" FNPT	3/4" MNPT	1/4" FNPT	70	265	16	5
MRHS-530-2	HydroScientific™ SB 5 x 30" Multi Filter Housing, ML, EP	2" FNPT	3/4" MNPT	1/4" FNPT	105	397	24	5
MRHS-540-2	HydroScientific™ SB 5 x 40" Multi Filter Housing, ML, EP	2" FNPT	3/4" MNPT	1/4" FNPT	140	530	32	5
MRHS-710-2	HydroScientific™ SB 7 x 10" Multi Filter Housing, ML, EP	2" FNPT	3/4" MNPT	1/4" FNPT	49	185	11	7
MRHS-720-2	HydroScientific™ SB 7 x 20" Multi Filter Housing, ML, EP	2" FNPT	3/4" MNPT	1/4" FNPT	98	371	22	7
MRHS-730-2	HydroScientific™ SB 7 x 30" Multi Filter Housing, ML, EP	2" FNPT	3/4" MNPT	1/4" FNPT	147	556	33	7
MRHS-740-2	HydroScientific™ SB 7 x 40" Multi Filter Housing, ML, EP	2" FNPT	3/4" MNPT	1/4" FNPT	196	742	45	7
MRHS-1230-3FL	HydroScientific™ SB 12 x 30" Multi Filter Housing, ML, EP	3" FL	1" FNPT	1/4" FNPT	252	954	57	12
MRHS-1240-3FL	HydroScientific™ SB 12 x 40" Multi Filter Housing, ML, EP	3" FL	1" FNPT	1/4" FNPT	336	1272	76	12
MRHS-2230-4FL	HydroScientific™ SB 22 x 30" Multi Filter Housing, ML, EP	4" FL	1" FNPT	1/2" FNPT	462	1749	105	22
MRHS-2240-4FL	HydroScientific™ SB 22 x 40" Multi Filter Housing, ML, EP	4" FL	1" FNPT	1/2" FNPT	616	2332	140	22
MRHS-3630-6FL	HydroScientific™ SB 36 x 30" Multi Filter Housing, ML, GB	6" FL	1" FNPT	1/2" FNPT	756	2862	172	36
MRHS-3640-6FL	HydroScientific™ SB 36 x 40" Multi Filter Housing, ML, GB	6" FL	1" FNPT	1/2" FNPT	1008	3816	229	36
MRHS-5230-6FL	HydroScientific™ SB 52 x 30" Multi Filter Housing, ML, GB	6" FL	1" FNPT	1/2" FNPT	1092	4134	248	52
MRHS-5240-6FL	HydroScientific™ SB 52 x 40" Multi Filter Housing, ML, GB	6" FL	1" FNPT	1/2" FNPT	1456	5512	331	52
MRHS-8530-8FL	HydroScientific™ SB 85 x 30" Multi Filter Housing, ML, GB	8" FL	1" FNPT	1/2" FNPT	1785	6757	405	85
MRHS-8540-8FL	HydroScientific™ SB 85 x 40" Multi Filter Housing, ML, GB	8" FL	1" FNPT	1/2" FNPT	2380	9009	649	85

SB = SWING BOLT, ML = LEGS, EP = ELECTROPOLISH, GB = GLASS BEAD

APPLICATIONS

- Residential, Commercial, Industrial, and Municipal
- Reverse Osmosis Pre-filtration
- Ground Water Remediation
- Industrial Process (High Purity) Applications
- Cooling Tower Filtration
- Process Water
- Industrial Waste Water Treatment

FEATURES

- Electropolished/Glass Bead 304 or 316 Stainless Steel.
- Swing Bolt Design for Safe/Easy Operation.
- Accepts DOE, 222/Flat or 222/Fin Cartridges.
- Heavy duty legs included on all models.
- Vented lid and Clean and Dirty Drains on all models.
- Two gauge ports on inlet and outlet on all models.
- Flow rates up to 2,380 gpm - 9,009 lpm - 649 m³/hr.

ADDITIONAL FEATURES

Finish: Electropolished and Bead Blasted Standard
 Drains: Clean and Dirty standard on all models
 Gauge Ports: Clean and Dirty standard on all models
 Cartridge Types: MRH DOE Style Cartridges (2-3/4" max. dia.)
 All MRH Filter Housings will accept DOE, 222/Flat or 222/Fin Cartridges Standard

MATERIALS OF CONSTRUCTION

Housing Shell: 304 or 316 Stainless Steel
 Lid Closure: Zinc Plated Steel
 Vent and Drain Plugs: 304 or 316 Stainless Steel
 Heavy Duty Mounting Legs: 304 or 316 Stainless Steel
 O-Ring/Gasket: EPDM - FDA Grade
 (Vitron, Silicone and EPR Options)

OPERATIONAL DATA

Max. Working Pressure: 150 psi at 300°F (10.3 bar at 149°C)
 Max. Operating Temperature: 300 °F (149 °C)



4.5" STAINLESS STEEL SINGLE ELEMENT FILTER HOUSINGS

HF45SS SERIES



HYDROSCIENTIFIC™ SS SINGLE CARTRIDGE HOUSINGS

are ideal for commercial and industrial filter application. Made with Heavy duty 304 or 316 stainless steel construction for maximum durability, HF45SS Series housings accept 4 1/2" diameter (Big Blue style) Double Open-End (DOE) cartridges. Designed for high temperature and high-pressure applications, the HF45SS series housings ring nut closure provides quick cartridge change outs.

HYDROSCIENTIFIC™ SS SINGLE CARTRIDGE HOUSINGS

incorporate a spring-loaded knife edge seal into the housings, this provides positive sealing for variable length cartridges. Numerous gasket options are available for compatibility with most fluids.



HF45SS SERIES - 304 SS SINGLE CARTRIDGE HOUSINGS SPECIFICATIONS

Part Number	Description	Ports (In/Out)	Drains
HF4510SS-10	HydroScientific™ 10" Single Filter Housing, accepts 4.5" x 10" Filter Cartridge	1" FNPT	1/4" FNPT
HF4520SS-10	HydroScientific™ 20" Single Filter Housing, accepts 4.5" x 20" Filter Cartridge	1" FNPT	1/4" FNPT

HF45SS SERIES - 316 SS SINGLE CARTRIDGE HOUSINGS SPECIFICATIONS

Part Number	Description	Ports (In/Out)	Drains
HF4510SS-10-316	HydroScientific™ 10" Single Filter Housing, accepts 4.5" x 10" Filter Cartridge	1" FNPT	1/4" FNPT
HF4520SS-10-316	HydroScientific™ 20" Single Filter Housing, accepts 4.5" x 20" Filter Cartridge	1" FNPT	1/4" FNPT

4.5" STAINLESS STEEL SINGLE ELEMENT FILTER HOUSINGS

HF45SS SERIES



FEATURES

- Spring loaded Knife Edge Seal.
- Commercial and Industrial Filter Application.
- Ring Nut Closure for Quick Cartridge Change Outs.
- High Temperature and High-Pressure Applications.
- Heavy Duty 304 or 316 Stainless Steel Construction.
- Accepts 4 1/2" diameter (Big Blue style) Double Open-End (DOE) cartridges.
- 1/4" FNPT Drain Port Standard.

APPLICATIONS

- Chemicals
- Electronics
- Wastewater
- Potable Water
- Food & Beverage
- RO Prefiltration
- Plating Solutions
- Coolants / Inks / Paints / Coatings
- Photographic Solutions

PORT DIMENSIONS

Drain: 1/4" FNPT
 Inlet: 1" FNPT
 Outlet: 1" FNPT

MATERIALS OF CONSTRUCTION

Body: 304 or 316 Stainless Steel
 Head: 304 or 316 Stainless Steel
 O-Ring: EPDM

OPERATIONAL DATA

Max. Working Pressure: 300 psi (20.68 bar)
 Max. Operating Temperature: 200 °F (93 °C)

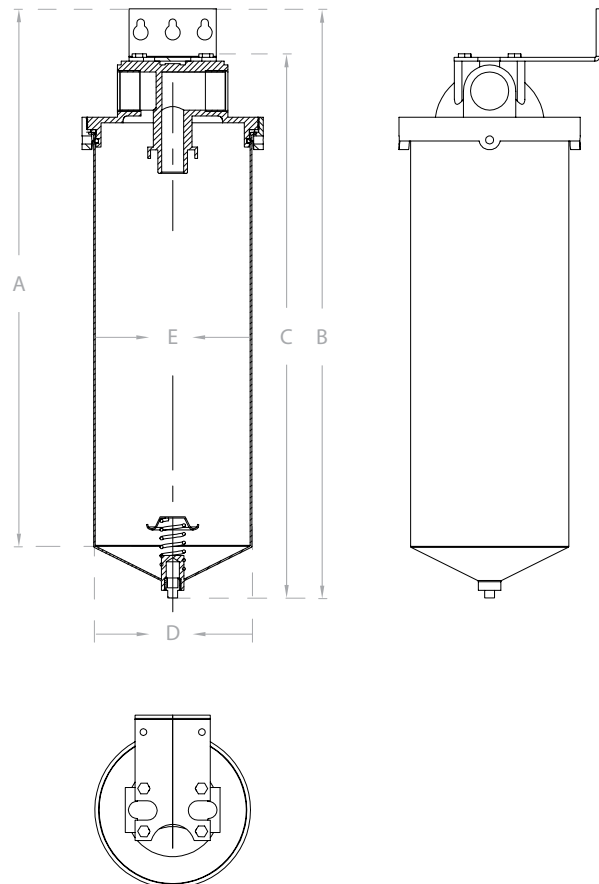

HF45SS SERIES DIMENSIONS

MODEL	A Length	B Length	C Length	D OD Diameter	E ID Diameter
10"	13.58"	18.62"	16.97"	4.89"	4.82"
20"	23.58"	28.62"	26.97"	4.89"	4.82"

Copyright © 2019 HydroScientific., All Rights Reserved.



STAINLESS STEEL SINGLE ELEMENT FILTER HOUSINGS

T SERIES



HYDROSCIENTIFIC™ T SERIES STAINLESS STEEL HOUSINGS are designed for industrial and commercial filter applications. Their heavy-duty construction for maximum durability allows them to be used in a wide range of applications and process requirements.

HYDROSCIENTIFIC™ T SERIES STAINLESS STEEL HOUSINGS accept Double Open End (DOE) and Single Open End (SOE), 222 connector cartridges and are available with 3/4" and 1" in-line connections for easy installation. Constructed of 304 or 316 Stainless Steel, T Series housings are the ideal housings for higher pressure, higher temperature liquid applications where plastic housings are not an option.

T SERIES - 304 SS HOUSING SPECIFICATIONS				
Part Number	Description	Ports (In/Out)	Max. Flow Rate (gpm)	Max. Flow Rate (lpm)
T1-304-34	HydroScientific™ 10" Single Filter Cup Housing, DOE	3/4" FNPT	7	26.5
T1-304-10	HydroScientific™ 10" Single Filter Cup Housing, DOE	1" FNPT	7	26.5
T1-304-34-222	HydroScientific™ 10" Single Filter Cup Housing, 222, U-Cup	3/4" FNPT	7	26.5
T1-304-10-222	HydroScientific™ 10" Single Filter Cup Housing, 222, U-Cup	1" FNPT	7	26.5
T2-304-34	HydroScientific™ 20" Single Filter Cup Housing, DOE	3/4" FNPT	14	53
T2-304-10	HydroScientific™ 20" Single Filter Cup Housing, DOE	1" FNPT	14	53
T2-304-34-222	HydroScientific™ 20" Single Filter Cup Housing, 222, U-Cup	3/4" FNPT	14	53
T2-304-10-222	HydroScientific™ 20" Single Filter Cup Housing, 222, U-Cup	1" FNPT	14	53

T SERIES - 316 SS HOUSING SPECIFICATIONS				
Part Number	Description	Ports (In/Out)	Max. Flow Rate (gpm)	Max. Flow Rate (lpm)
T1-316-34	HydroScientific™ 10" Single Filter Cup Housing, DOE	3/4" FNPT	7	26.5
T1-316-10	HydroScientific™ 10" Single Filter Cup Housing, DOE	1" FNPT	7	26.5
T1-316-34-222	HydroScientific™ 10" Single Filter Cup Housing, 222, U-Cup	3/4" FNPT	7	26.5
T1-316-10-222	HydroScientific™ 10" Single Filter Cup Housing, 222, U-Cup	1" FNPT	7	26.5
T2-316-34	HydroScientific™ 20" Single Filter Cup Housing, DOE	3/4" FNPT	14	53
T2-316-10	HydroScientific™ 20" Single Filter Cup Housing, DOE	1" FNPT	14	53
T2-316-34-222	HydroScientific™ 20" Single Filter Cup Housing, 222, U-Cup	3/4" FNPT	14	53
T2-316-10-222	HydroScientific™ 20" Single Filter Cup Housing, 222, U-Cup	1" FNPT	14	53

STAINLESS STEEL SINGLE ELEMENT FILTER HOUSINGS

T SERIES



FEATURES

- Ideal for Commercial and Industrial Filter Application.
- Heavy duty 304 or 316 Stainless Steel Construction.
- Accepts 2 1/2" diameter Double Open-End (DOE), Single Open-End (SOE), 222 connector cartridges with Fin or Flat ends.
- Available with 3/4", and 1" in-line connections for easy installation.
- Ring nut closure for quick cartridge change outs.
- Equipped with mounting bracket kit and wrench.
- Numerous gasket options for compatibility with most fluids.
- 1/4" FNPT Drain Port.

APPLICATIONS

- Water
- Chemicals
- Food & Beverage
- Coolants
- Pulp & Paper
- Electronics
- Oil
- Inks / Paints / Coatings

MATERIALS OF CONSTRUCTION

Body: 304 or 316 Stainless Steel
 Head: 304 or 316 Stainless Steel
 O-Ring: Silicone (Standard)

PORT DIMENSIONS

Drain: 1/4" FNPT
 Inlet: 3/4" FNPT
 Outlet: 3/4" FNPT
 Vent: 1/4" FNPT

OPERATIONAL DATA

Max. Working Pressure: 300 psi (20.68 bar)
 Max. Operating Temperature: 250 °F (121 °C)- (Body Only)

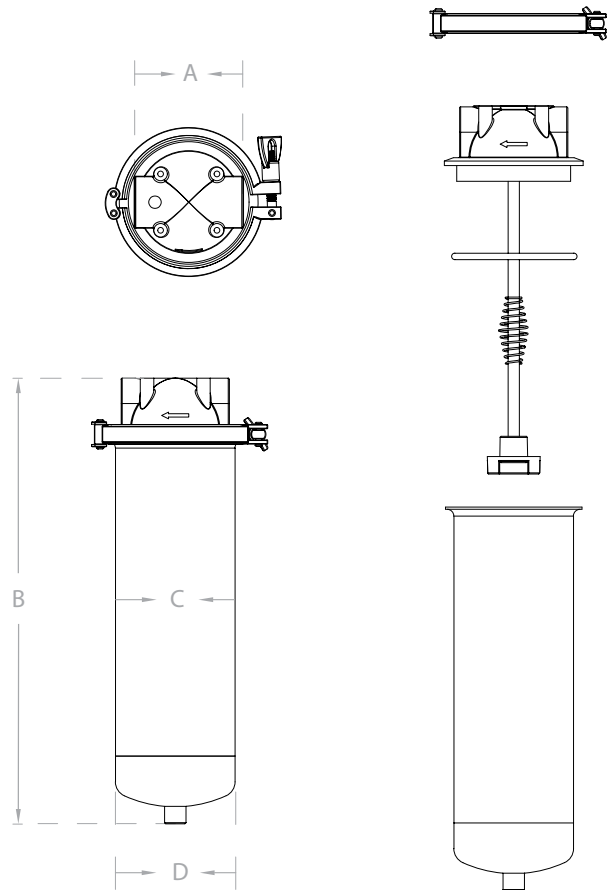

T SERIES DIMENSIONS

MODEL	A Length	B Length	C ID Diameter	D OD Diameter
10"	3.82"	15.55"	4.06"	4.17"
20"	3.82"	25.40"	4.06"	4.17"

HYDRONIX WATER TECHNOLOGY (HDX) & HYDROSCIENTIFIC (HDS) LIMITED WARRANTY

1. HDX / HDS warrants their full line of residential, commercial, industrial and municipal filter housings to be free of defects in material and workmanship for a period of (1) one year from the date of installation.
2. HDX / HDS filter housings ordered with special coatings is limited only to the re-coating of the defective parts due to the failure in materials or workmanship for a period of one year from the date of installation.
3. HDX / HDS filter housing warranty does not cover any filter housing failure which the product is not suited. Buyer must be responsible for suitable application.
4. HDX / HDS Warranty Excludes:
 - HDX / HDS Carbon Steel, 304 and 316 Stainless Steel Filter Housing used in Sea Water Applications.
 - HDX / HDS filter housing that is not grounded. All filter housings must be grounded.
 - HDX / HDS is not liable for any cost of labor or expenses related to installation or removal of filter housing(s).
 - HDX / HDS filter housing that has been modified from original design.
 - HDX / HDS filter housing O-rings, gaskets and all wear items.
 - HDX / HDS filter housings that was damaged by galvanic or electrolytic attack.
 - HDX / HDS filter housing name plate (label) removal.
 - HDX / HDS filter damaged by chemical attack.
 - HDX / HDS filter damaged by improper installation, operation or service.
5. HDX / HDS Warranty Claims must have authorized RGA (Returned Goods Authorization) submitted by Hydronix Water Technology
6. HDX / HDS Warranty Claims must provide the following information:
 - HDX / HDS customer must provide detailed outline of the problem
 - HDX / HDS filter housing part number
 - HDX filter housing serial number
 - HDX customer must provide date of purchase and date of installation
 - HDX must provide contact information



P.O. Box 2235 Chino Hills, CA 91709 • USA

TERMS & CONDITIONS



PRODUCT RETURN POLICY

Any item to be returned requires prior authorization from seller's customer service department, by phone (909.527.6996) or by fax (909.527.6997). Requests for returns of merchandise (other than materially defective merchandise) must be within one (1) year from the date of the seller's invoice date. The purchaser's order number or seller's invoice number must be provided when requesting the authorization. Seller must have an invoice on file for the product requested to be returned. Seller reserves the right to deny requested product returns. Approved returns will be issued a return authorization number (RMA#) from seller's customer service department. Product returned without prior authorization by seller will be refused. Approved returns will be given a return authorization number (RMA#). The (RMA#) must be plainly displayed on the outside of the parcel or parcels being returned or packages will be refused. Product must be returned within sixty (60) days upon issuance of the RMA#. If product is not returned within sixty (60) days, the RMA will be void and any packages returned will be refused.

Items said to be defective will be submitted to seller's Quality Control Department for evaluation and, if determined to be a material manufacturing defect, credit or a replacement will be issued as seller's option. Items sent out incorrectly by seller will be credited upon return of the product. A replacement order will be sent upon request by purchaser. Items to be returned as a result of over-stock, being incorrectly ordered, on an order cancelled by purchaser, will be assessed a 25% restocking charge and the company sending the returns will be responsible for return freight charges. All items returned, with the exception of goods claimed materially defective must be in even case lots, in their original packaging, and in new and unused condition. Any product returned failing to meet the above guidelines will be destroyed with no credit issued. Any items returned to seller without seller's authorization or an RMA# will be refused. For further questions regarding this policy, contact the Sales Department at (909.527.6996).

ADDITIONAL CONDITIONS AND NOTES

1. All list prices are quoted in US Dollars.
2. **MINIMUM ORDER VALUE - \$100 NET** F.O.B Rancho Cucamonga, CA. Accepted emergency orders will receive a minimum order charge (difference between \$100 minimum and order total).
3. **SPECIAL HANDLING SERVICE** - Orders requiring special handling are subject to approval to Hydronix Customer Service Department. A charge of \$50 may be applied to accepted orders requiring "special handling" (e.g. drop shipments, expedited/rush shipments, etc.). Freight terms for drop ship orders will be either pre-pay and add or 3rd party billing sold to customer. Only Hydronix packing slips will accompany the shipment. Hydronix reserves the right to refuse requests to drop ship orders or special handling requests.
4. Product sold in case lot quantities only. Contact distributors for price and availability of lesser quantities.
5. Housings and Systems are priced without cartridges unless stated otherwise.
6. Nominal micron ratings are based on average values obtained in commercial production and are not intended for specifications purpose.
7. For information on additional product availability, contact our sales department.

WARNING: DO NOT use with water that is microbiologically unsafe or of unknown quality without adequate disinfected water that may contain filterable cysts.

CAUTION: Filter must be protected against freezing which can cause cracking of the filter and result in water leakage.

CAUTION: Filter should not be installed where exposed to direct sunlight.

CAUTION: Do not expose clear housings to organic solvents as those found in aerosol sprays, cleaning products, or insecticides. Such exposure may cause filter damage, failure, cracking and leakage. After installation, flush the cartridge with sufficient water to remove fines before using water. Run tap at least 20 seconds prior for drinking or cooking purposes.

NOTE: Some harmless bacteria may attack cellulose media cartridges. If cartridge appears to disintegrate or has a "musty" or "moldy" odor, switch to a synthetic media cartridge or consult manufacturer.

NOTE: Filter cartridges have a limited service life, changes in taste, odor, color and/or flow may indicate cartridge needs replacing.

WE RESERVE THE RIGHT TO CHANGE DESIGN, SPECIFICATIONS OR PRICE WITHOUT NOTICE.

TERMS OF USE AGREEMENT : MEDIA FILES *(Artwork, Images, Logos, Product Names, Slogans, Drawings)*

1. **Acceptance of Agreement.** You agree to the terms and conditions outlined in this Terms of Use Agreement ("Agreement") with respect to the Media Files of Hydronix Water Technology. No media files shall be used until you receive a signed copy of this Agreement from Hydronix Water Technology.
2. **Right.** "Media Files" shall mean the artwork, graphics, images, logos, product names, slogans, drawings, photographs, videos, digital images, audio/visual recordings and all related material of Hydronix Water Technology. Media Files are protected under applicable copyrights, trademarks and other proprietary (including but not limited to intellectual property) rights. The copying, redistribution, use or publication by you of any Media Files or any part of them, except as allowed by Section 4, is strictly prohibited. You shall not acquire ownership rights to any Media Files.
3. **Trademarks.** Hydronix, Polaris Scientific UV, Hydrofit, Hydron, HydroScientific, SHOK BLOK, Aquatrol, HydroGuard and _____ are trademarks, registered trademarks and/or licensed for use of Hydronix Water Technology.
4. **Limited Right to Use.** The use of Media Files is limited to printing only. Unless otherwise specified in a writing signed by an authorized representative of Hydronix Water Technology, Hydronix Water Technology grants you only a limited, nonexclusive agreement of use and does not authorize distribution, assignment, sublicense, sale, preparation of derivative works or other use. No part of any Media File may be reproduced in any form or incorporated into any information retrieval system, electronic or mechanical, including web pages other than for your personal corporate internal use without written permission granted by the Vice President or President of Hydronix Water Technology. All advertisements, sales sheets, catalog pages, informational newsletters or any other form of communication containing all or part of the Media Files must be approved by Hydronix Water Technology prior to use, printing and distribution. You shall provide Hydronix Water Technology with a copy of any advertisements, sales sheets, catalog pages, informational newsletters or any other form of communication containing all or part of the Media Files. Hydronix Water Technology reserves the right for permission of use and can require cease of use and deletion of previously approved media files.
5. **Editing, Deleting and Modification.** We reserve the right in our sole discretion to edit or delete any Media Files and enforce the use of Specific Media Files or represent specific products, salesmarks, logos and slogans.
6. **Indemnification.** You agree to indemnify, defend and hold us and our partners, attorneys, staff, employees, agents and affiliates harmless from any liability, loss, claim and expense, including reasonable attorney's fees and costs, related to your violation of this Agreement.
7. **Nontransferable.** Your right to use the Media Files is not transferable.
8. **Miscellaneous.** This Agreement shall be governed by and construed in accordance with the laws of the State of California (without regard to conflict of law principles). Any cause of action by you with respect to Media Files, or any information, products or services related thereto, must be instituted within one (1) year after the cause of action arose or be forever waived and barred. The language in this Agreement shall be interpreted as to its fair meaning and not strictly for or against either party. All legal proceedings arising out of or in connection with this Agreement shall be brought in California. You expressly submit to the exclusive jurisdiction of said courts and consent to extra-territorial service of process. Should any part of this Agreement be held invalid or unenforceable, that portion shall be construed consistent with applicable law and the remaining portions shall remain in full force and effect. To the extent that anything in or associated with the Media Files is in conflict or inconsistent with this Agreement, this Agreement shall take precedence. Our failure to enforce any provision of this Agreement shall not be deemed a waiver of such provision or of the right to enforce such provision.



P.O. Box 2235 Chino Hills, CA 91709 | USA

**PUT THE
TO WORK
FOR YOU!**



A **HYDRONIX** Company
HydroScientific™ is a registered trademark
and a division of Hydronix Water Technology™

sales@hydronixwater.com

© 2020-2021 HYDROSCIENTIFIC™ All Rights Reserved.
LIT-HDS-CAT20V1 01/28/20